

BW RTR - FIAA - Asset Accounting

- General presentation
 - List of contacts
 - Objective of the application
 - Usage information
 - History
- Rules
 - Roles and access
 - Authorization objects
- Dataflow overview
 - Functional and Technical rules on Workbench + Reporting
 - Rules & Explanations
 - Systems involved
 - Subject
 - Dependencies with other applications
- Data Model
 - Info providers and objects
 - DSOs
 - Cubes
 - Multi Providers
 - Main Master Data
 - Main Extractors
 - Process chain
 - Data Flow
- Data loading
 - Process Chain
 - Loading frequency
 - Average performance
 - Record Keeping
- Reporting
 - Queries End User Documentation
 - Main queries
 - Main functionalities
 - Broadcast
- Maintenance
 - Known bugs
 - Recurring procedure
 - Planned Evolution
 - Additional links
 - Useful transactions to be used for checking data

General presentation

The application loads data about asset accounting from ECC (just Rhodia RCS) into BW.

It is done daily using delta process via process chain schedule.

List of contacts

- [ROLLIER, Charlotte](#) (SBS Information Services) : Reporting Coordinator
- Guillaume Thevenet (SBS Information Services) : BW Coordinator

Objective of the application

The objective of FIAA in BW is to report the asset valorization and depreciation.

Usage information

Around 25 users, worldwide with daily update

Statistics by infoproviders

InfoProvider Used		Zone	DEC 2015	JAN 2016	FEB 2016	MAR 2016	APR 2016	MAY 2016	JUN 2016	JUL 2016
MPRO/MPR_FAA2	FIAA: DSO Period Values and Transactions	AP	14	11	11	19	36	12	13	12
		EU	3	1						4
		#	35	35	35	35	35	35	35	35
MPRO/MPR_FAA4	FIAA: Period Values and Transactions	AP	1			1			1	

		EU	9	5	4	13	22	15	14	19
		LA								3
		NA						0		
		#					1			
Overall Result			62	52	50	68	94	62	63	73

Statistics by queries

InfoProvider	Query		DEC 2015	JAN 2016	FEB 2016	MAR 2016	APR 2016	MAY 2016	JUN 2016	JUL 2016
MPR_FAA2	BW_QRY_MPR_FAA2_1001	FIAA Balance Sheet by Flow (WB & BD)	21	18	18	26	43	19	20	18
	BW_QRY_MPR_FAA2_1002	FIAA Acquisition by CGU and Sites (WorkB)	1							1
	BW_QRY_MPR_FAA2_1003	FIAA Fixed Assets Closing Bal. by CGU (BroadC)	28	28	28	28	28	28	28	28
	BW_QRY_MPR_FAA2_1004	FIAA Detailed Evaluation Accounting Grid (Core)	2	1						4
MPR_FAA4	BW_QRY_MPR_FAA4_1001	FIAA FC L3005 Bal. Sheet by Flow (Core) - OBSOLETE				1				
	BW_QRY_MPR_FAA4_1002	FIAA FC L6710 Acqui. by CGU and Sites (Core)	2						2	
	BW_QRY_MPR_FAA4_1004	FIAA Detailed Evaluation Accounting Grid - Posted (WorkB)	8	5	4	13	22	15	13	22
	BW_QRY_MPR_FAA4_1005	FIAA AuC not yet brought into service (Core)					0	0		
	BW_QRY_MPR_FAA4_1007	FIAA Five-yearly Inventory Report (Core)					1		0	
	BW_QRY_MPR_FAA4_1014	FIAA Report Insurance Values (Core)								
Result			62	52	50	68	94	62	63	73

-

History

This project was developed in 2011 by Leonardo Andrade with BW technical support of Nestor Araujo.

Rules

Roles and access

Role Code	Role Description	Explanation
ZR_RCS_CA_M33	User Reporting FIAA	role menu

Authorization objects

List of authorization objects mandatory for the application.

Authorization object	Explanation
ZBI_FIAA	Asset Accounting
ZBI_FIAA_K	Asset Accounting key users
ZR_RCS_CA_M33	Asset Accounting menu

PS: the roles Z_FIAA and Z_FIAA_K are obsolete

Authorization: ZBI_FIAA Last Changed: NARAUJO 07.02.2015
 Short Text: Accounting Asset Status: Active (Revised)
 Medium Text: Accounting Asset
 Long Text: Accounting Asset



Auth. Structure

Charact./Dimensions	Description	Intervals	Node
<u>OCO AREA</u>	Controlling area	×	
<u>OEHS AUTH</u>	Authorization Group	×	
<u>OEHS SPEC OEHS AUTH</u>	Authorization Group	×	
<u>OPERS AREA</u>	Personnel Area	×	
<u>OPLANT</u>	Plant	×	
<u>OPROFIT CTR OPLANT</u>	Plant	×	
<u>OPROFIT CTR CPFCTR1 2</u>	BFC Global Business Unit	×	
<u>OPROFIT CTR C PFCTR1</u>	1 - RCS Global Business Unit	×	
<u>OTCAACTVT</u>	Activity in Analysis Authorizations	[]	
<u>OTCAIPROV</u>	Authorizations for InfoProvider		
<u>OTCAKYFNM</u>	Key Figure in Analysis Authorizations	×	
<u>OTCAVALID</u>	Validity of an Authorization	×	
<u>OTCTAUTHH</u>	Authorization for hierarchy	×	
<u>C BFCA 2 C BFCA 4</u>	BFC GBU (FC GBU)	×	
<u>C BFCA 4</u>	BFC GBU (FC GBU)	×	
<u>C BU PS</u>	Business Unit (for Project System)	×	
<u>C CCRESP</u>	Person Responsible	×	
<u>C CNTRY 0</u>	Country of Origin	×	
<u>C COSTCTR</u>	Cost Center	×	
<u>C COSTCTR C FUNCT 2</u>	2 Function	×	
<u>C FAMIL</u>	Family of WBS element	×	
<u>C FAMINPR</u>	Family of investment project	×	
<u>C FUNCT 2</u>	2 Function	×	
<u>C FUNCT 3</u>	3 Sub-function Grouping	×	
<u>C MATPLNT C PFCTR1</u>	1 - RCS Global Business Unit	×	
<u>C MA PR C BFCA 4</u>	BFC GBU (FC GBU)	×	

<u>C MA PR C FAMINPR</u>	Family of investment project	x	
<u>C MA PR C PLANT</u>	Plant	x	
<u>C PFCTR1</u>	ERP Global Business Unit	x	
<u>C PFCTR2</u>	ERP Group of activities	x	
<u>C PLANT</u>	Plant	x	
<u>C REG</u>	Regulatory List	x	
<u>C RESP CC C FUNCT 3</u>	Resp CC - 3 Sub-function Grouping	x	
<u>C VALSTR</u>	Value Stream	x	
<u>C WBS EL2 C FAMIL</u>	Family of WBS element	x	
<u>C WBS EL2 C PLANT</u>	Plant	x	
<u>C WBS EL2 C ZSECT</u>	Global Business Unit	x	
<u>C WBS ELE OPLANT</u>	Plant	x	
<u>C WBS ELE C FAMIL</u>	Family of WBS element	x	
<u>C WBS ELE C ZSECT</u>	Global Business Unit	x	
<u>C ZSECT</u>	Global Business Unit	x	

See also file maintained by Authorization team :

- BW Catalog of Roles: [Authorization catalog](#)
- BW Authorization: [BW Authorizations](#)

Dataflow overview

Reporting documentation drive folder:

Example of dataflow overview :

Functional and Technical rules on Workbench + Reporting

Rules & Explanations

Systems involved

- Rhodia ERP WP1
- Solvay ERP PF1 (just the DSO COEP - line item settlement with status)

Subject

All changes done with assets in ERP are sent to BW, like: acquisitions, depreciations, revaluations, retirements, transfers, general changes.

Dependencies with other applications

There is an integration with BW Project (PS) linking the DSOCOEPD with ODS_WBS6 (Rhodia) and DSO6COEP with ODS6WBS6 (Solvay).

Data Model

Info providers and objects

DSOs

- DSOCOEPD - CO Object: Line Item Settlement With Status

- DSO6COEP - CO Object: Line Item Settlement With Status - Solvay
- DSO_FAA2 - FIAA: Annual Values
- DSO_FAA3 - FIAA: Period Values
- DSO_FAA1 - FIAA: Transactions

Cubes

- CUB_FAA4 - FIAA : Period Value
- CUB_FAA2 - FIAA: Annual Value
- CUB_FAA1 - FIAA: Cumulated Movements
- CUB_FAA3 - FIAA: Transactions

Multi Providers

- MPR_FAA3 - Annual Values and Transactions
- MPR_FAA1 - FIAA: DSO Annual Values and Transactions
- MPR_FAA2 - FIAA: DSO Period Values and Transactions
- MPR_FAA4 - FIAA: Period Values and Transactions

Main Master Data

- 0ASSET - Asset Sub-number
- C_ASSET - Asset Sub-number
- C_ASSET2 - Asset Sub-number
- C_AT_AFAB - Depreciation Area Real or Derived
- C_AT_AFA2 - Depreciation Area Real or Derived (not compound)

Main Extractors

- 0FI_AA_11 - FI-AA: Transactions

Field Attributes										
Pos.	Field	Descript.	D...	T..	Data type	Lngh	Deci...	Exter...	L..	K..
1	BUKRS	Company Code		<input checked="" type="checkbox"/>	CHAR	4	0	0	<input type="checkbox"/>	<input type="checkbox"/>
2	ANLN1	Asset		<input checked="" type="checkbox"/>	CHAR	12	0	0	<input type="checkbox"/>	<input type="checkbox"/>
3	ANLN2	Subnumber		<input checked="" type="checkbox"/>	CHAR	4	0	0	<input type="checkbox"/>	<input type="checkbox"/>
5	FISCPER	Fiscal year/period		<input checked="" type="checkbox"/>	NUMC	7	0	0	<input type="checkbox"/>	<input type="checkbox"/>
6	LNRAN	Sequence Number		<input checked="" type="checkbox"/>	NUMC	5	0	0	<input type="checkbox"/>	<input type="checkbox"/>
7	AFABER	Deprec. area		<input checked="" type="checkbox"/>	NUMC	2	0	0	<input type="checkbox"/>	<input type="checkbox"/>
8	BWASL	Trans. Type		<input checked="" type="checkbox"/>	CHAR	3	0	0	<input type="checkbox"/>	<input type="checkbox"/>
9	WAERS	Currency		<input checked="" type="checkbox"/>	CUKY	5	0	0	<input type="checkbox"/>	<input type="checkbox"/>
10	PERIV	Fi. Year Variant		<input checked="" type="checkbox"/>	CHAR	2	0	0	<input type="checkbox"/>	<input type="checkbox"/>
11	BW_ANSBW_T	Acq.Value for Tra...		<input checked="" type="checkbox"/>	CURR	13	2	0	<input type="checkbox"/>	<input type="checkbox"/>
12	BW_INVBW_T			<input checked="" type="checkbox"/>	CURR	13	2	0	<input type="checkbox"/>	<input type="checkbox"/>
13	BW_NAFAB_T	O.dep. on trans		<input checked="" type="checkbox"/>	CURR	13	2	0	<input type="checkbox"/>	<input type="checkbox"/>
14	BW_SAFAB_T	S.dep. on trans		<input checked="" type="checkbox"/>	CURR	13	2	0	<input type="checkbox"/>	<input type="checkbox"/>
15	BW_AAFAB_T	Unpl.Dep.on Tra...		<input checked="" type="checkbox"/>	CURR	13	2	0	<input type="checkbox"/>	<input type="checkbox"/>
16	BW_MAFAB_T	Transf.of Reserves		<input checked="" type="checkbox"/>	CURR	13	2	0	<input type="checkbox"/>	<input type="checkbox"/>
17	BW_ZINSB_T	Int. on trans.		<input checked="" type="checkbox"/>	CURR	13	2	0	<input type="checkbox"/>	<input type="checkbox"/>
18	BW_AUFBW_T			<input checked="" type="checkbox"/>	CURR	13	2	0	<input type="checkbox"/>	<input type="checkbox"/>
19	BW_AUFNP_T	Reval.Ord. Dep.T...		<input checked="" type="checkbox"/>	CURR	13	2	0	<input type="checkbox"/>	<input type="checkbox"/>
20	BW_NAFAW_T	Tr:Acc.dep/wr-u...		<input checked="" type="checkbox"/>	CURR	13	2	0	<input type="checkbox"/>	<input type="checkbox"/>
21	BW_SAFAW_T	Tr:Acc.dep/wr-u...		<input checked="" type="checkbox"/>	CURR	13	2	0	<input type="checkbox"/>	<input type="checkbox"/>
22	BW_AAFAW_T	Acc.Dep./Write-u...		<input checked="" type="checkbox"/>	CURR	13	2	0	<input type="checkbox"/>	<input type="checkbox"/>
23	BW_MAFAW_T	Tr:Acc.Dep./Wr...		<input checked="" type="checkbox"/>	CURR	13	2	0	<input type="checkbox"/>	<input type="checkbox"/>
24	BW_AUWWW_T	Acc.dep.on reval...		<input checked="" type="checkbox"/>	CURR	13	2	0	<input type="checkbox"/>	<input type="checkbox"/>
25	BW_AUFNW_T	Acc.dep/reval.de...		<input checked="" type="checkbox"/>	CURR	13	2	0	<input type="checkbox"/>	<input type="checkbox"/>
26	BW_INVZW_T	Acc.dep.on inv.s...		<input checked="" type="checkbox"/>	CURR	13	2	0	<input type="checkbox"/>	<input type="checkbox"/>
27	ERLBT	Retmt. revenue		<input checked="" type="checkbox"/>	CURR	13	2	0	<input type="checkbox"/>	<input type="checkbox"/>
28	VERKO	Ret. costs		<input checked="" type="checkbox"/>	CURR	13	2	0	<input type="checkbox"/>	<input type="checkbox"/>
29	MINERL	Loss		<input checked="" type="checkbox"/>	CURR	13	2	0	<input type="checkbox"/>	<input type="checkbox"/>
30	MEHERL	Gain		<input checked="" type="checkbox"/>	CURR	13	2	0	<input type="checkbox"/>	<input type="checkbox"/>

- 0FI_AA_12 - FI-AA: Posted Depreciation

Field Attributes										
Pos.	Field	Descript.	D...	T..	Data type	Lngh	Deci...	Exter...	L..	K..
1	BUKRS	Company Code		<input checked="" type="checkbox"/>	CHAR	4	0	0	<input type="checkbox"/>	<input checked="" type="checkbox"/>
2	ANLN1	Asset		<input checked="" type="checkbox"/>	CHAR	12	0	0	<input type="checkbox"/>	<input checked="" type="checkbox"/>
3	ANLN2	Subnumber		<input checked="" type="checkbox"/>	CHAR	4	0	0	<input type="checkbox"/>	<input checked="" type="checkbox"/>
4	AFABER	Deprec. area		<input checked="" type="checkbox"/>	NUMC	2	0	0	<input type="checkbox"/>	<input checked="" type="checkbox"/>
5	WAERS	Currency		<input checked="" type="checkbox"/>	CUKY	5	0	0	<input type="checkbox"/>	<input type="checkbox"/>
6	FISCPER	Fiscal year/period		<input checked="" type="checkbox"/>	NUMC	7	0	0	<input type="checkbox"/>	<input type="checkbox"/>
7	PERIV	Fi. Year Variant		<input checked="" type="checkbox"/>	CHAR	2	0	0	<input type="checkbox"/>	<input type="checkbox"/>
8	BW_KNAFA_P	Per.St: Acc.Ord...		<input checked="" type="checkbox"/>	CURR	13	2	0	<input type="checkbox"/>	<input type="checkbox"/>
9	BW_KSAFA_P	Per: Acc.Spec.De...		<input checked="" type="checkbox"/>	CURR	13	2	0	<input type="checkbox"/>	<input type="checkbox"/>
10	BW_KAAFA_P	Period:Acc.Unpl...		<input checked="" type="checkbox"/>	CURR	13	2	0	<input type="checkbox"/>	<input type="checkbox"/>
11	BW_KMAFA_P	Per: Ac.Res. Tran...		<input checked="" type="checkbox"/>	CURR	13	2	0	<input type="checkbox"/>	<input type="checkbox"/>
12	BW_KAUFN_P	Cum.reval.O.dep		<input checked="" type="checkbox"/>	CURR	13	2	0	<input type="checkbox"/>	<input type="checkbox"/>
13	BW_KAUFW_P	Cum.reval.of RV		<input checked="" type="checkbox"/>	CURR	13	2	0	<input type="checkbox"/>	<input type="checkbox"/>
14	BW_KZINS_P	Interest posted		<input checked="" type="checkbox"/>	CURR	13	2	0	<input type="checkbox"/>	<input type="checkbox"/>
15	BW_NAFAG_P	Per:Pstd ord.dep.		<input checked="" type="checkbox"/>	CURR	13	2	0	<input type="checkbox"/>	<input type="checkbox"/>
16	BW_SAFAG_P	Per: Pstd spec.d...		<input checked="" type="checkbox"/>	CURR	13	2	0	<input type="checkbox"/>	<input type="checkbox"/>
17	BW_AAFAG_P	Per: Pstd Unpl.D...		<input checked="" type="checkbox"/>	CURR	13	2	0	<input type="checkbox"/>	<input type="checkbox"/>
18	BW_MAFAG_P	Per:Post. Trans.R...		<input checked="" type="checkbox"/>	CURR	13	2	0	<input type="checkbox"/>	<input type="checkbox"/>
19	BW_AUFNG_P	Pst.rev.cumOdep		<input checked="" type="checkbox"/>	CURR	13	2	0	<input type="checkbox"/>	<input type="checkbox"/>
20	BW_AUFWG_P	Reval. posted		<input checked="" type="checkbox"/>	CURR	13	2	0	<input type="checkbox"/>	<input type="checkbox"/>
21	BW_ZINSG_P	Interest posted		<input checked="" type="checkbox"/>	CURR	13	2	0	<input type="checkbox"/>	<input type="checkbox"/>
23	KOSTL	Cost Center		<input checked="" type="checkbox"/>	CHAR	10	0	0	<input type="checkbox"/>	<input type="checkbox"/>
24	FKBER	Functional Area		<input checked="" type="checkbox"/>	CHAR	16	0	0	<input type="checkbox"/>	<input type="checkbox"/>
25	CAUFN	Int. order		<input checked="" type="checkbox"/>	CHAR	12	0	0	<input type="checkbox"/>	<input type="checkbox"/>
26	EAUFN	Order		<input checked="" type="checkbox"/>	CHAR	12	0	0	<input type="checkbox"/>	<input type="checkbox"/>
27	IAUFN	Maintnce order		<input checked="" type="checkbox"/>	CHAR	12	0	0	<input type="checkbox"/>	<input type="checkbox"/>
28	FISTL	Funds Center		<input checked="" type="checkbox"/>	CHAR	16	0	0	<input type="checkbox"/>	<input type="checkbox"/>
29	PS_PSP_PNR	WBS Element		<input checked="" type="checkbox"/>	NUMC	8	0	0	<input type="checkbox"/>	<input type="checkbox"/>
30	SIM			<input checked="" type="checkbox"/>	CHAR	1	0	0	<input type="checkbox"/>	<input type="checkbox"/>
31	GEBER	Fund		<input checked="" type="checkbox"/>	CHAR	10	0	0	<input type="checkbox"/>	<input type="checkbox"/>
37	IMKEY	Real Estate Key		<input checked="" type="checkbox"/>	CHAR	8	0	0	<input type="checkbox"/>	<input type="checkbox"/>

- 0ASSET_AFAB_ATTR - Depreciation Area Real or Derived

Field Attributes										
Pos.	Field	Descript.	D...	T..	Data type	Lngh	Deci...	Exter...	L..	K..
1	BUKRS	Company Code		<input checked="" type="checkbox"/>	CHAR	4	0	0	<input type="checkbox"/>	<input checked="" type="checkbox"/>
2	ANLN1	Asset		<input checked="" type="checkbox"/>	CHAR	12	0	0	<input type="checkbox"/>	<input checked="" type="checkbox"/>
3	ANLN2	Subnumber		<input checked="" type="checkbox"/>	CHAR	4	0	0	<input type="checkbox"/>	<input checked="" type="checkbox"/>
4	AFABER	Deprec. area		<input checked="" type="checkbox"/>	NUMC	2	0	0	<input type="checkbox"/>	<input checked="" type="checkbox"/>
5	AFABG	Ord.dep.Start		<input checked="" type="checkbox"/>	DATS	8	0	0	<input type="checkbox"/>	<input type="checkbox"/>
6	ZINBG	Int.calc.start		<input checked="" type="checkbox"/>	DATS	8	0	0	<input type="checkbox"/>	<input type="checkbox"/>
7	SAFBG	Spec.dep.start		<input checked="" type="checkbox"/>	DATS	8	0	0	<input type="checkbox"/>	<input type="checkbox"/>
8	AFASL	Dep. key		<input checked="" type="checkbox"/>	CHAR	4	0	0	<input type="checkbox"/>	<input type="checkbox"/>
9	NDJAR	Useful life		<input checked="" type="checkbox"/>	NUMC	3	0	0	<input type="checkbox"/>	<input type="checkbox"/>
10	NDPER	Periods		<input checked="" type="checkbox"/>	NUMC	3	0	0	<input type="checkbox"/>	<input type="checkbox"/>
11	KTANSW	Bal.sh.acct APC		<input checked="" type="checkbox"/>	CHAR	10	0	0	<input type="checkbox"/>	<input type="checkbox"/>
12	KTOPL	Chart of Accts		<input checked="" type="checkbox"/>	CHAR	4	0	0	<input type="checkbox"/>	<input type="checkbox"/>
18	ZZNDABJ_LY	Exp. usefl life		<input checked="" type="checkbox"/>	NUMC	3	0	0	<input type="checkbox"/>	<input type="checkbox"/>
19	ZZNDABJ_CY	Exp. usefl life		<input checked="" type="checkbox"/>	NUMC	3	0	0	<input type="checkbox"/>	<input type="checkbox"/>
20	ZZNDABP_LY	Expired UL per.		<input checked="" type="checkbox"/>	NUMC	3	0	0	<input type="checkbox"/>	<input type="checkbox"/>
21	ZZNDABP_CY	Expired UL per.		<input checked="" type="checkbox"/>	NUMC	3	0	0	<input type="checkbox"/>	<input type="checkbox"/>
22	ZZUMJAR	Changeover year		<input checked="" type="checkbox"/>	NUMC	4	0	0	<input type="checkbox"/>	<input type="checkbox"/>
23	ZZSCHRW	Scrap value		<input checked="" type="checkbox"/>	CURR	13	2	0	<input type="checkbox"/>	<input type="checkbox"/>
24	ZZSCHRW_PROZ	Scrap Value %		<input checked="" type="checkbox"/>	DEC	14	11	0	<input type="checkbox"/>	<input type="checkbox"/>
25	ZZWAERS	Currency		<input checked="" type="checkbox"/>	CUKY	5	0	0	<input type="checkbox"/>	<input type="checkbox"/>

Process chain

- PC_FIAA - FI - Asset Accounting

Data Flow

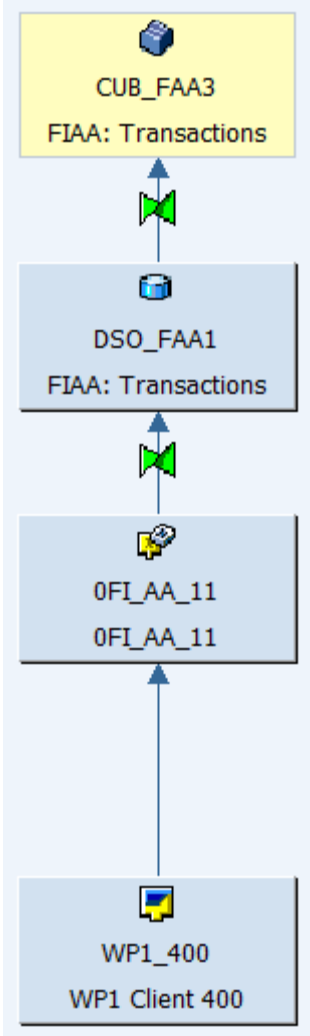
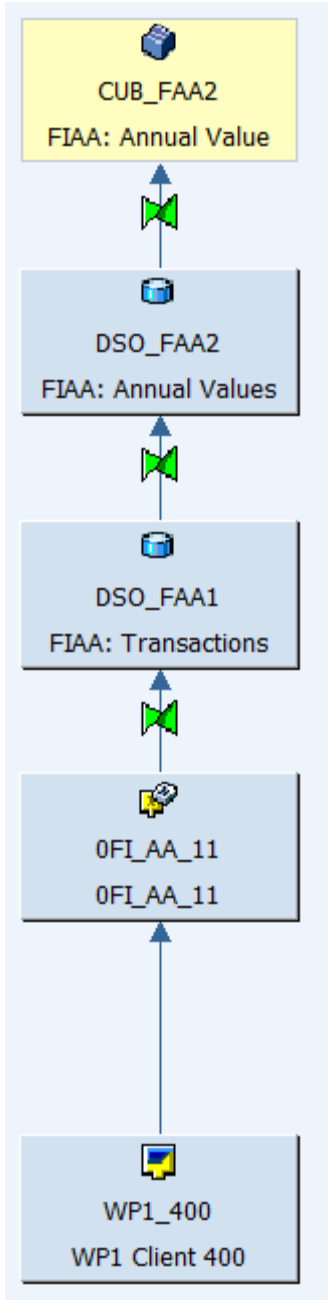
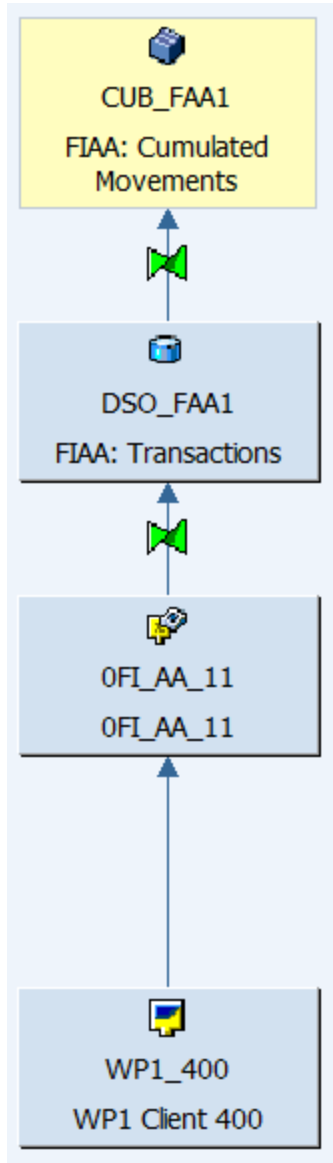

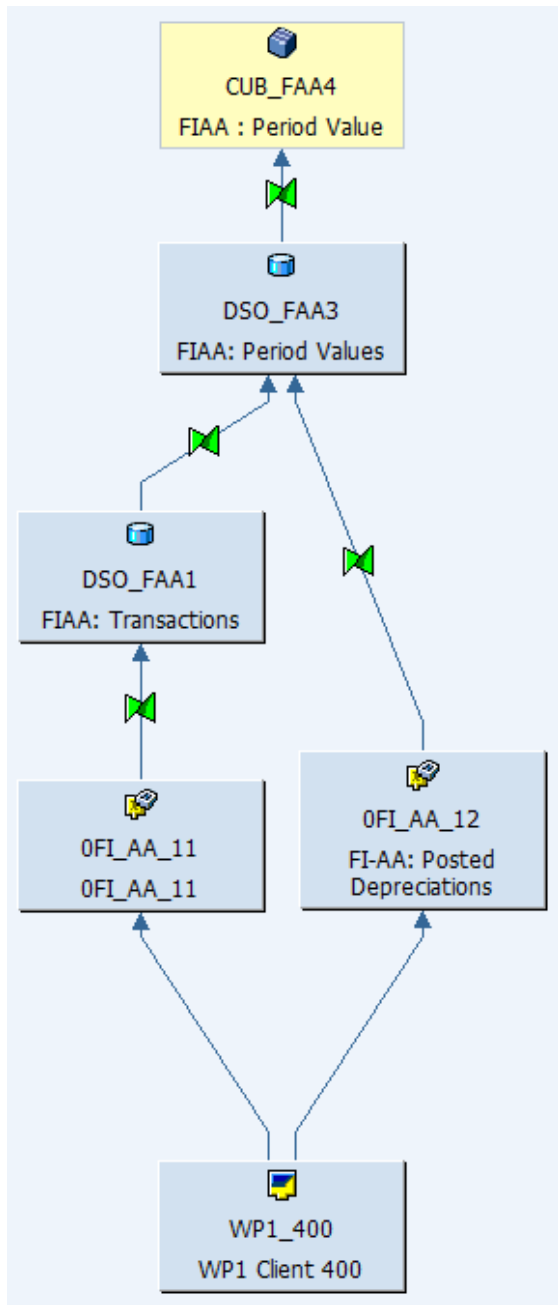

Data loading

Process Chain

The process chain that loads all delta movements in FIAA is PC_FIAA - FI - Asset Accounting (see below).

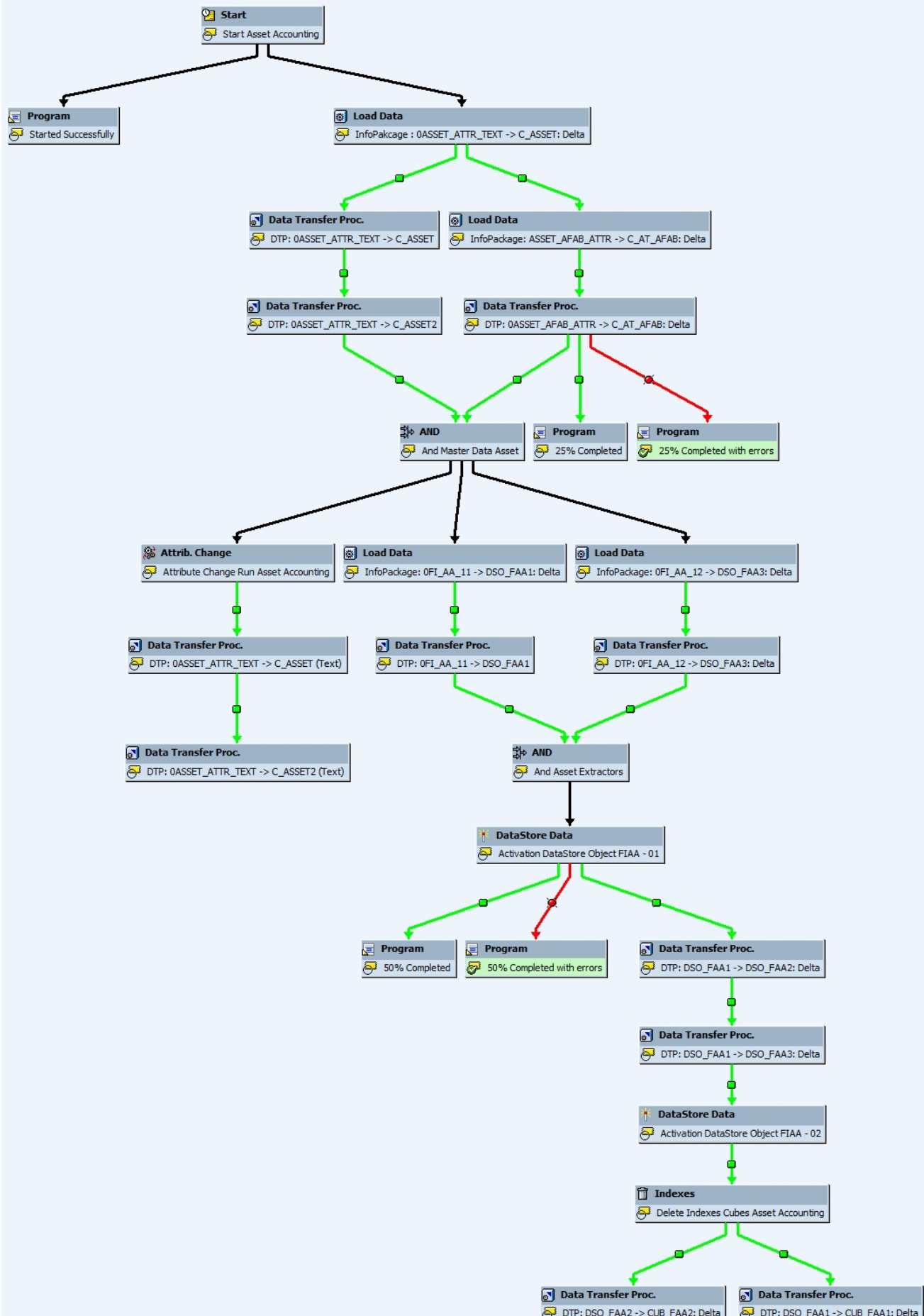

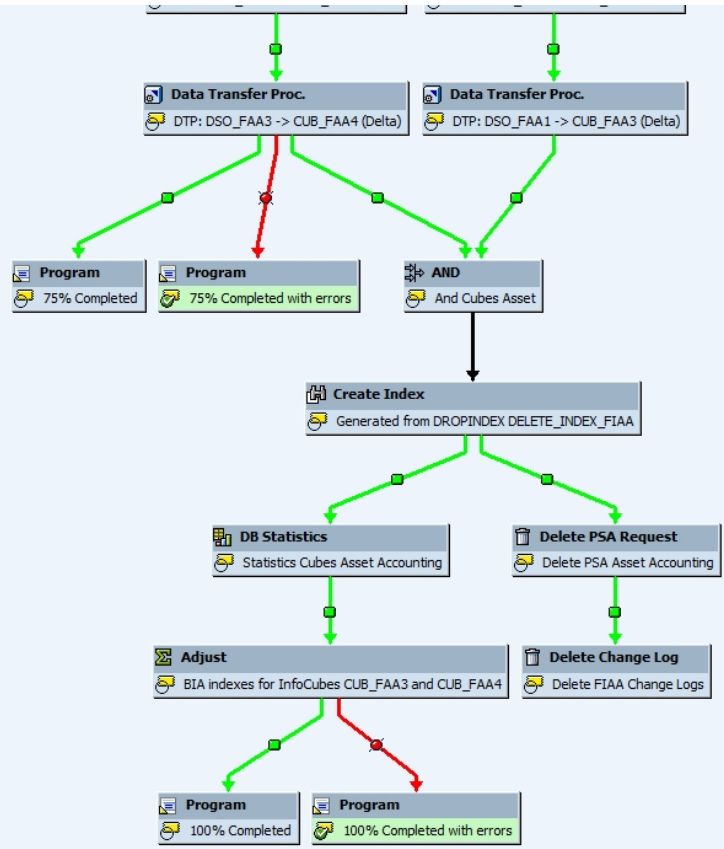

Loading frequency

The data load is done daily in delta mode.

Average performance

Daily process chain loaded in 50 minutes average with around 60K records inserted from delta mode process

Status	Steps	Main	Chain	Log-Id	SubChains	Steps	Day	Date	Time	Runtime	Runtime [sec]	End Date	End Time
○○	○○		PC_FIAA	56NYSE0XQAIT3NM604B7L03EN	0	35	MO	25.07.2016	21:56:27	01:06:18	3.978	25.07.2016	23:02:46
○○	○○		PC_FIAA	56LDYM8Y05OKR3FMN6KP7A6Z	0	35	SU	24.07.2016	22:20:58	00:47:41	2.861	24.07.2016	23:08:39
○○	○○		PC_FIAA	56JWOJLHSAAPPZ0R1UJDY803LR	0	35	TH	21.07.2016	21:27:44	00:42:18	2.538	21.07.2016	22:10:01
○○	○○		PC_FIAA	56LFBN6VZPPL64YH1B8D8DTFJ	0	35	WE	20.07.2016	21:18:48	00:42:33	2.553	20.07.2016	22:01:21
○○	○○		PC_FIAA	56JMAJYPAR63IMSLVH029EEKF	0	35	TU	19.07.2016	21:26:16	00:40:48	2.448	19.07.2016	22:07:04
○○	○○		PC_FIAA	56KEESGX7LCVYXMRV05HGV5MN	0	35	MO	18.07.2016	21:28:30	00:40:21	2.421	18.07.2016	22:08:51
○○	○○		PC_FIAA	56L6UXNP TPPMIS8NYXYIHSEM7	0	35	MO	18.07.2016	02:42:11	03:42:14	13.334	18.07.2016	06:24:24
○○	○○		PC_FIAA	56IUUNV9QA778MCLMFXOKF03J	0	35	TH	14.07.2016	21:34:23	00:42:27	2.547	14.07.2016	22:16:50
○○	○○		PC_FIAA	56JD15F7LM045R122011KA2BJ	0	35	WE	13.07.2016	21:31:13	00:39:10	2.350	13.07.2016	22:10:23
○○	○○		PC_FIAA	56J242D3VIEZ763HBXIIBJ4U7	0	35	TU	12.07.2016	21:33:04	00:39:37	2.377	12.07.2016	22:12:41
○○	○○		PC_FIAA	56HNEH7GR738UR1A5XFBU0HFJ	0	35	MO	11.07.2016	21:26:52	00:38:50	2.330	11.07.2016	22:05:42
○○	○○		PC_FIAA	56HFWW7R1ILNHGZOUU8JX24VZ	0	35	SU	10.07.2016	22:45:20	00:41:08	2.468	10.07.2016	23:26:27
○○	○○		PC_FIAA	56G8UOQU0492IOS190ZRLT0SF	0	35	TH	07.07.2016	21:23:34	00:45:33	2.733	07.07.2016	22:09:07
○○	○○		PC_FIAA	56GNN3GA1IAFZENV9ZKW7KFGF	0	35	WE	06.07.2016	21:28:28	00:39:09	2.349	06.07.2016	22:07:37
○○	○○		PC_FIAA	56G5BN8TJ7AFCVTA2RON1PR2Z	0	35	TU	05.07.2016	21:37:09	00:47:23	2.843	05.07.2016	22:24:32
○○	○○		PC_FIAA	56IUI3JADFZVY6YVWHT280DYNN	0	35	MO	04.07.2016	21:29:59	00:43:53	2.633	04.07.2016	22:13:52
○○	○○		PC_FIAA	56DU1RP9VABT81YKPUTOGD33Z	0	35	SU	03.07.2016	23:09:41	00:44:02	2.642	03.07.2016	23:53:43
○○	○○		PC_FIAA	56DQ0LS38PZHG3NNJ5VQFIHXB	0	35	TH	30.06.2016	21:40:01	00:48:53	2.933	30.06.2016	22:28:54
○○	○○		PC_FIAA	56DISEV52K09DELWYMCBDCLRZ	0	35	WE	29.06.2016	21:29:39	00:54:12	3.252	29.06.2016	22:23:51
○○	○○		PC_FIAA	56CULXYVB1OJD8V3WW42F7P6N	0	35	TU	28.06.2016	21:34:03	01:02:54	3.774	28.06.2016	22:36:57
○○	○○		PC_FIAA	56BJ2W3M5F5MIMLR2DR365CUZ	0	35	MO	27.06.2016	21:18:25	00:47:32	2.852	27.06.2016	22:05:57
○○	○○		PC_FIAA	56C8CLHR2MO05QYGHDO0PW9QZ	0	35	SU	26.06.2016	21:20:13	00:44:23	2.663	26.06.2016	22:04:37

Key Figure	Estimation
~ Average Process Chain Runtime	50 to 80 minutes
~ Average nb of rows loaded per load	100K to 1200K records (all providers)
~ Total nb of rows loaded (if full)	DSO_FAA1 (58.000K) since 2011
	DSO_FAA2 (19.000K) since 2011
	DSO_FAA3 (19.000K) since 2011
~ Average Runtime for 10k lines	30 minutes

For details about application load monitoring, click in following link: [Application Monitoring](#)

Record Keeping

The data is kept since 2011.

Reporting

Queries End User Documentation

[BW Asset Queries](#)

Main queries

Name
[BW_QRY_MPR_FAA2_0001] FIAA Asset History Sheet (for Dep)
[BW_QRY_MPR_FAA2_0003] FIAA Asset Balance (S_ALR_87011963) (Core)
[BW_QRY_MPR_FAA2_0004] FIAA AuC not yet brought into service (Core)
[BW_QRY_MPR_FAA2_1001] FIAA Balance Sheet by Flow (WB & BD)
[BW_QRY_MPR_FAA2_1002] FIAA Acquisition by CGU and Sites (WorkB)
[BW_QRY_MPR_FAA2_1003] FIAA Fixed Assets Closing Bal. by CGU (BroadC)
[BW_QRY_MPR_FAA2_1004] FIAA Detailed Evaluation Accounting Grid (Core)
[BW_QRY_MPR_FAA4_1001] FIAA FC L3005 Bal. Sheet by Flow (Core) - OBSOLETE
[BW_QRY_MPR_FAA4_1002] FIAA FC L6710 Acqui. by CGU and Sites (Core)
[BW_QRY_MPR_FAA4_1003] FIAA FC L6720 Fixed Assets Closing Bal. by CGU (Core) - OBSO
[BW_QRY_MPR_FAA4_1004] FIAA Detailed Evaluation Accounting Grid - Posted (WorkB)
[BW_QRY_MPR_FAA4_1005] FIAA AuC not yet brought into service (Core)
[BW_QRY_MPR_FAA4_1006] FIAA Impairment statement by CGU (Core)
[BW_QRY_MPR_FAA4_1007] FIAA Five-yearly Inventory Report (Core)
[BW_QRY_MPR_FAA4_1011] FIAA FC L3005 Bal. Sheet by Flow (WorkB)
[BW_QRY_MPR_FAA4_1013] FIAA FC L6720 Fixed Assets Closing Balance by CGU (WorkB)
[BW_QRY_MPR_FAA4_1013_WBK_RSA] FIAA FC L6720 Fixed Assets Closing Bal. CGU RSA (WorkB)
[BW_QRY_MPR_FAA4_1014] FIAA Report Insurance Values (Core)
[BW_QRY_MPR_FAA4_1015] FIAA FC L3005 Bal. Sheet by Flow - Posted dep. (Core)
[BW_QRY_MPR_FAA4_1016] FIAA FC L3005 Bal. Sheet by Flow - Planned dep. (Core)
[BW_QRY_MPR_FAA4_1017] FIAA FC L6720 Fixed Assets Closing Bal. by CGU - Posted dep.
[BW_QRY_MPR_FAA4_1018] FIAA FC L6720 Fixed Assets Closing Bal. by CGU - Planned dep
[BW_QRY_MPR_FAA4_1019] FIAA Detailed Evaluation Accounting Grid - Planned (Core)

Main functionalities

See details about key figures in this link: [BW Asset Queries - key figure definition](#)

Broadcast

There is a process chain BD_AAC - Asset Accounting Broadcast that is responsible to run the list of broadcasts below:

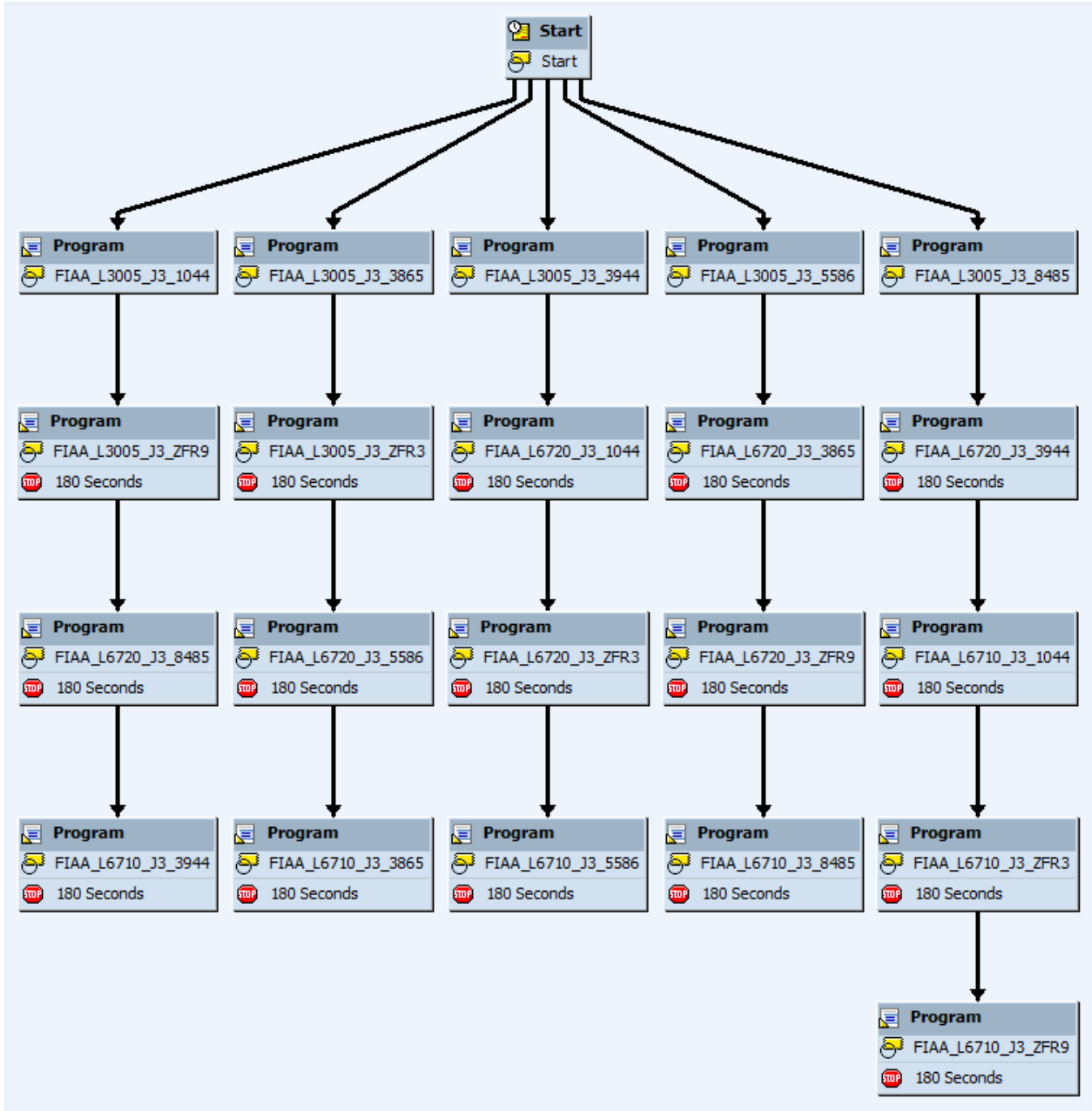

For instance, variant L3005_J3_ZFR3

Program to Call

Program

Program Name: RSRD_BROADCAST_STARTER

Program Variant: L3005_J3_ZFR3

Selection Scrns	Field name	Type	I/E	Option	frm	to
1000	Technical Name of Setti...	P			FIAA_L3005_J3_ZFR3	
1000	ID of the Predefined Ti...	S				
1000	Techn. Name of InfoPro...	S				
1000	Execute Online	P				
	P_LOGHND	P				
	List of Settings	S				
	P_BTCHID	P				

Schedule

Group description	Cell Content
Broadcast Setting	FIAA_L3005_J3_ZFR3
Version	A
Long description	L3005 - J3 - ZFR3-ROP
Object Status	ACT
Object Type	WB
Technical Name of Object	EBO025HJCE7XNRF2CIE72EJ4K
Distribution Type	MAIL
Distribution Type Description	Broadcast E-mail
Output Format	XLS
Output Format Description	MS Excel Workbook
Person Responsible	BW_BCAST
Date of Creation	25.04.2012

There is no schedule for FIAA workbooks.

Settings for Object Type: Workbook | Overview of Scheduled Settings

Description	Technical Name	Owner	Last Changed	Scheduled
No Settings Available for Workbook FIAA - FC L3005 Balance Sheet by Flow (Core WorkBook) (A5CD8W7RZLTWW5JFE2TYFDYDW)				

The setting below is empty.

Recipient(s) | Texts | Workbook Precalculation

User:

User in Role:

E-Mail Addresses: Nestor.Araujo-EXTERNAL@solvay.com

Authorization User: NARAUJO

Language: English

User-specific:

Broadcast settings

Maintenance

Known bugs

There is no ticket opened for FIAA for more than 2 years.

Recurring procedure

There is no list of recurring procedures

Planned Evolution

There is no evolution planned by FIAA, maybe the in future the Solvay data will be integrated to the BW FIAA, but the source system control must be implemented for that.

Additional links

See below a list of interest documents with additional information about Asset Accounting.

- [Asset Accounting](#)
- [Asset management](#)
- [RCS fixed assets - new CORE design_EN](#)
- [RCS Asset Global Presentation](#)
- [Creating a completed fixed asset](#)
- [RCS FI-AA Fixed Assets](#)
- [FAA Closing period](#)

Useful transactions to be used for checking data

Transaction	Description	Corresponding table	Comments
AS03	Asset Display	ANLA, ANLB	in ERP
AW01N	Asset Explorer	ANLA, ANLB	in ERP
CJ03	Display Project WBS Element	PROJ, PRPS	in ERP
RSCUR	Currency conversion	TCURR	in BW

Pages... WBP Applications [Skip to end of banner](#)

[blocked URL](#) [Go to start of banner](#)