

BW PTP - SPRINT (including SRM7, PUNCH, Purchasing VBF) (WBP) /\ Obsolete /\



The new wiki link for this data flow is here:

[Technical Documentation - Procurement - SPRINT report](#)

Please update the new doc there and no longer here.



- General presentation
 - Objective of the application
 - Usage information
 - History
- Roles & Access
 - Roles and access
 - Authorization objects
- Dataflow overview
- Functional and Technical rules on Workbench + Reporting
 - Rules & Explanations
 - Data Mappings
 - SPRINT - Data Mapping - Master Data
 - SPRINT - Data Mapping - Purchase Schedule Line V2
 - Masterdata RULE1 on Vendors (C_VENDID) / Class attribut (C_VENCLS)
 - Masterdata RULE2 on Realigned Material Group (C_MATPUR2)
 - Masterdata RULE3 on Terms of Payment (C_PMNTTRM)
 - ReadSoft DataFlow
 - WBS determination reading Settlement Rules
 - Segmentation Segment/Domain/Cost Sub Package/Cost Package/Cost Macro Package
 - Cost Package mapping
 - Segment
 - Organization (P)
 - LeadTime
 - Calculation of compliance delta and flag for FIAP dso
 - Material Group (C_MAT_GRP)
 - Original Material Group (C_OMATGRP)
 - Conversion rate used in reports
 - Documentation for Document/MasterData Modifications extractors
 - Master Data Attributes & Texts loaded via Web Dynpro
 - KeyFigures in "summation" mode
 - Cytec data flow & procedures
 - BOZAR data flow & procedures (VBF)
 - PO2 change
 - Dependencies with other applications
 - SPRINT New Data Flows with Advanced DSOs
 - Composite Provider CPPURSPD01
 - aDSO ABMMPUCS1
 - aDSO ABMMPUCS2
 - aDSO ABMMCY01
 - aDSO ABPOPUHD1
 - aDSO ABPOPUHD2
 - Process Chains
- Data loadings
 - Info providers and objects loaded
 - Main Chains
 - Sub Chains
 - Chains for WebDynpro
 - Other Chains
 - Loading frequency
 - Average performance
 - Record Keeping
- Reporting
 - Queries End User Documentation
 - Main queries
 - Main functionalities
 - MaintenanceBroadcast
 - Known bugs
 - Recurring procedure
 - Variables (TVARV/Global Filters)
 - FIAP Reloading
 - FIAP Specifics Rules

- DB_FIAP3 - FIAP for SPRINT (Acetow):
- Status of payment
- Link with factoring level (CAMS project).
- Exclusion of some accounting document number:
- FIGL Specifics Rules
 - Be careful, there is a rule between propagation DSO and business DSO to exclude lines with FIGL Domain not equal to "AP".
 - Exclusion of some accounting document number:
- FIGL Reloading
- ReadSoft Reloading
 - Manual update
- Value Creation
 - Data flow
 - Power of two update:
 - Master Data:
 - Technical points to pay attention
 - How monitoring the loading ?
 - Load data manually in case of issue
 - Load data manually from Salesforce
 - Working document
 - Contacts for value creation:
- SPRINT data exported to other applications
 - Open Hub
- Planned Evolution
- Useful transactions / programs

General presentation

Objective of the application

SPRINT stands for **S**olvay **P**urchasing **R**eporting **I**ntelligence

SPRINT is a project launched early 2014, with the main purpose to build and deliver a reporting application to cover both the Purchasing and the PtP reporting needs.

It is hosted in WBP server, collecting information from PF1-050 (PRS), PF1-020 (Solvay legacy ERP), WP1-400 (Rhodia legacy ERP) and RHO-020 (Acetow ERP).

SPRINT application is available for the two "family" of users

- Purchasing & Supply Chain function
- SBS PtP

each one having a dedicated Menu in WBP with the respective queries.

The objective of SPRINT is to offer a simplified global reporting solution for the PtP process, from procurement to payment, to meet the requirements of the **Purchasing and Supply Chain Excellence Function** and **SBS PtP process** : Access to the data, network, global projects, TCO Analysis / saving calculation & easy simulation



Consolidated KPIs for PtP process with Automatic Daily Frequency of loading :
 Exhaustive, accurate and updated data available for all users at any time in **one unique BW Reporting system** instead of the 2 different BW used previously

The Sprint reporting is also including queries based on following projects :

- PUNCH (QM Notification - Task/Activity/Causes/Item)
- SRM7 (Shopping Cards)

SRM7 is used by Rhodia and by Solvay (SMILES program is rolling out SRM7 for Solvay; first rollout for NAM and LATAM went live on July 1st 2014, next rollouts for APAC and EMEA planned go-live for 2015).The SRM7 system is shared by both legacies and is connected to both ERP systems.

Tool Leader + IT leader of the application:

Reporting Coordinator : Duarte Costa (Lisbon)

Purchasing & Supply Chain Solutions Coordinator : Karin WEIGEL-JUNG (Lyon)

Purchasing Data and P-t-P Interface Manager : Sylvie Severini (Bruxelles)

Purchasing and Supply Chain Excellence / Quality Leader : Cécilia Allain (Lyon)

Contact on ECC side for MM => Henri OLLIVIER

Usage information

History

SPRINT is a project launched early 2014. The roadmap of the project has been sliding in time and at the current date (January 2016) the Purchasing solution has been live for 9 months (first deployment made in March 2015 for APAC users, second deployment made in April 2015 for NAM users, third deployment between May and June 2015 for EMEA users and forth deployment in June 2015 for LAM users); the SBS PtP solution is partially deployed since June 2015.

One of the major objectives of the project is to have and maintain a reporting solution that is kept simple, meaning, that unlike what happened with GSV (where more than 80 queries exist due to multiple copies made for each user request), the aim for SPRINT is to keep the number of queries limited.

Roles & Access

Roles and access

List of application role + menu role and explanation if we have several applications role with specials rules.

Role Menu Code	Role application	Role Description	Explanation	Link queries
ZR_RCS_CA_M04	ZR_RCS_SPRINT2_A01	SPRINT - Purchasing	Role menu ZR_RCS_CA_M04 uses application role ZR_RCS_SPRINT2_A01 linked to IA_PUR_SPRINT* Authorization Object ZBI_SPRINT2 / Authorization on zone, GBU, Plant, Company Code.	
ZR_RCS_CA_M31	ZR_RCS_SPRINT2_A01	SPRINT - SBS - PTP	Role menu ZR_RCS_CA_M31 uses application role ZR_RCS_SPRINT2_A01 linked to IA_PUR_SPRINT* Authorization Object ZBI_SPRINT2 / Authorization on zone, GBU, Plant, Company Code.	Link
ZR_RCS_CA_M54	ZBI_RCS_SC_A01	SPRINT - Supplier Credit	Role menu ZR_RCS_CA_M54 uses application role ZBI_RCS_SC_A01 linked to IA_PUR_SC_* Authorization Object ZBI_SPRINT_SC / Authorization only on Company Code.	
ZR_RCS_CA_M59	ZBI_RCS_VBF_A01	Sprint - Value Based Fee	Role menu ZR_RCS_CA_M59 uses application role ZBI_RCS_VBF_A01, linked to IA_PUR_VBF_*	
ZR_RCS_CA_M62	ZR_RCS_SPRINT2_A01	Sprint - Value Creation	Role menu ZR_RCS_CA_M62 uses application role ZR_RCS_SPRINT2_A01, linked to IA_PUR_SPRINT_VC*.	
ZR_RCS_CA_M042	ZR_RCS_SPRINT2_A01	SPRINT - Purchasing Data	Role menu ZR_RCS_CA_M042 uses application role ZR_RCS_SPRINT2_A01 linked to IA_PUR_SPRINT* (only in wbd for the moment)	
?	?	?	? linked to IA_PUR_SPRINT_VWF*	

NB: The role menu ZR_RCS_ALL_MENU "Role composite with all role Menu and perimeters" gives access to all role menu. When asking for a new role menu, do not forget it is added to that one.

NB: ZR_RCS_SPRINT_A01 & ZR_RCS_SPRINT_A02 are obsolete

Authorization objects

List of autorisation objects mandatory for the application.

Authorization object	Explanation
Zone (C_PZONE)	ZR_*_CA_P11 Authorizations exist on this object, but all users have access to all (role ZR_TOUT2_CA_P11), this authorization on Zone is abandoned. NB: ZR_TOUT_CA_P11 is obsolete
GBU (C_SUBACT2__CPFCTR1_2)	ZR_*_CA_P05
Plant (C_PLANT)	ZR_*_CA_P02 ZR_7866_CA_P02 => Plant 7866 - Chalampé (ex 7027) - (Cie ZFR9) ZR_TOUT_CA_P02 => All Plants "Solvay"
Company Code (C_COMPCDE)	ZR_*_CA_P01 ZR_ZFR9_CA_P01 => BUTACHIMIE - (ZFR9) (ex 0560) ZR_TOUT_CA_P01 => All Companies "Solvay"

See also file maintained by Authorization team : BW Catalog of Roles / link: https://drive.google.com/open?id=10GEfKYqrT1eeTO_uHYAheL1GX7L5y_pvH0KQU64qh5l

Dataflow overview

Technical dataflow : SPRINT - Technical Data Flow.pptx <https://drive.google.com/file/d/1RRcSkxXHQa0o-luflyriZW0zVpBSF21V/view>

See also SPRINT Dataflow https://drive.google.com/file/d/1HAOEcKFoPxUN-GOEpGOh3fkAdj7Cx-_elg4I5pMvZNY/view

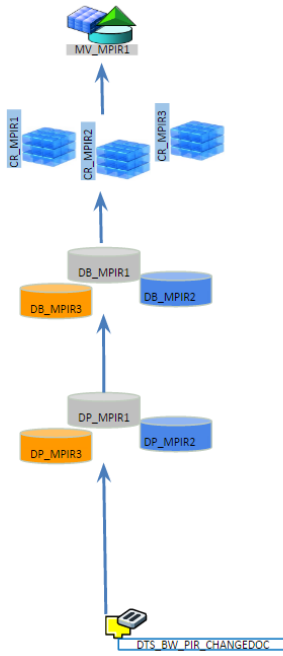
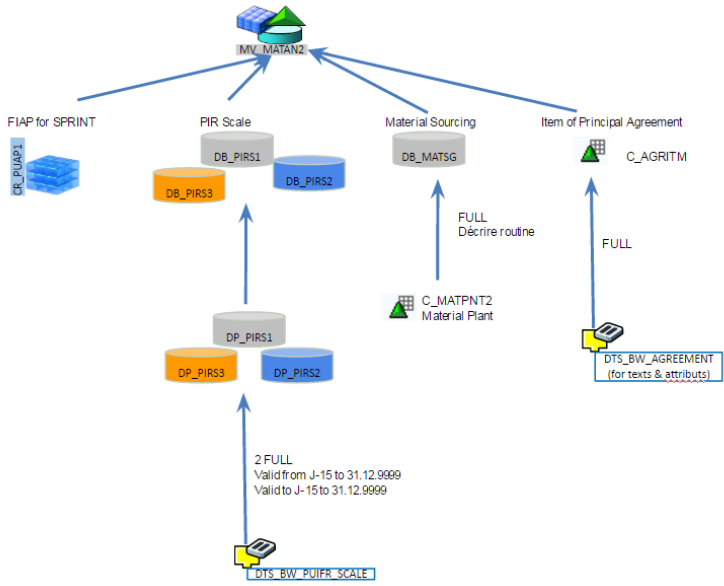
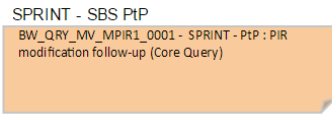
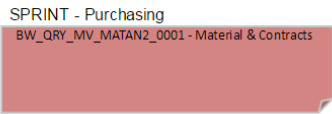
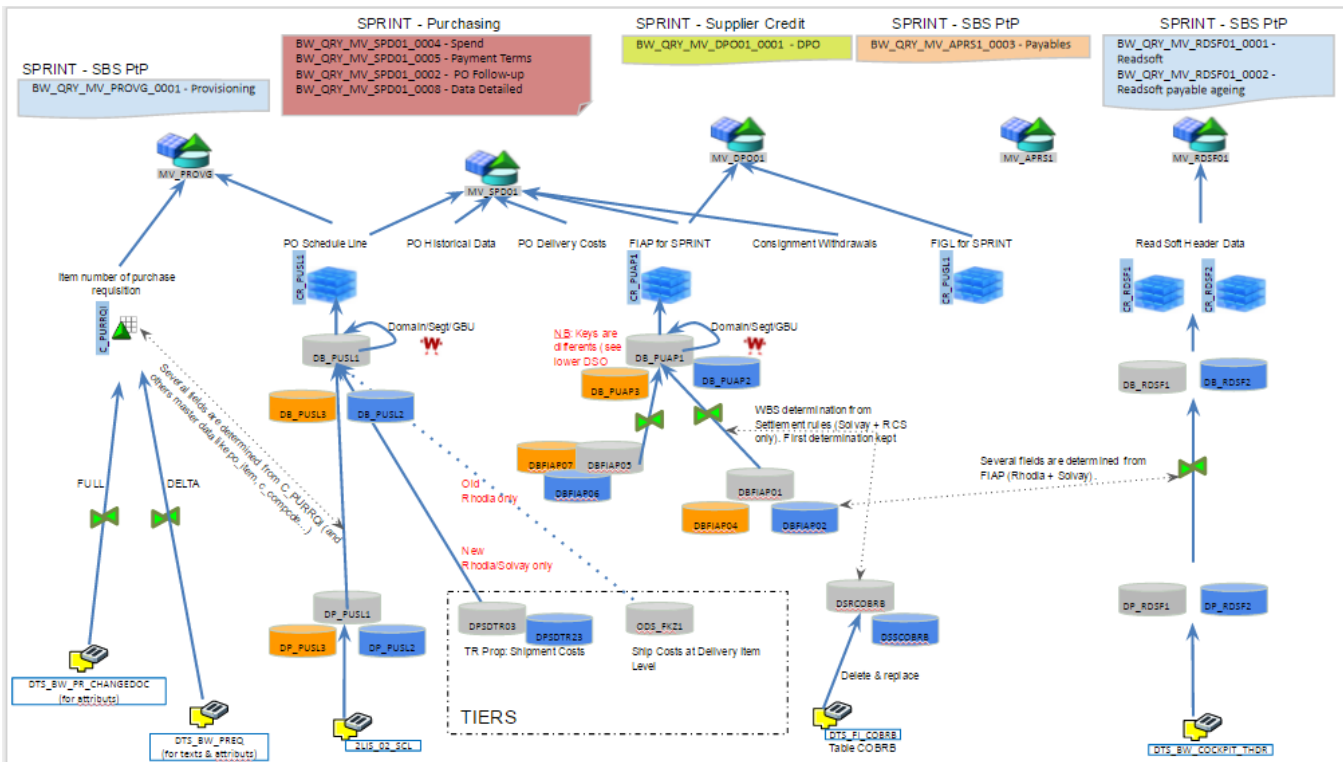

Reporting documentation drive folder:
<https://drive.google.com/drive/folders/OB0qn89R0RGdqYkZZOFZyYXIXVke>
<https://drive.google.com/drive/folders/1xSTPzNUz5Ai8qLCxI6Baqqys95YC5T-4>

Exemple of dataflow overview :

Functional and Technical rules on Workbench + Reporting

Rules & Explanations

Data Mappings

Directory 01. Data Mapping <https://drive.google.com/drive/folders/1jzgxSjU7G2I3iM5gnvKcKbNeyZwJI-iP>

SPRINT - Data Mapping - Master Data

https://drive.google.com/file/d/11D3zE-u8gb8O__TMAFU_eQrz47tNenNz9IDM3TtXMml/view

SPRINT - Data Mapping - Purchase Schedule Line V2

<https://drive.google.com/file/d/1-PBxl44Ok6r1U0vdsWKzWwS5ienVVtsZD8B9GRGA9A/view>

Masterdata RULE1 on Vendors (C_VENDID) / Class attribut (C_VENCLS)

This rule concerns only Solvay vendors (from PF1) P*, which are employees not existing in PRS.

These vendors are partly created in Solvay PF1 and it is then not possible to set Class = 'X' in Solvay PF1.

For those vendors, the class has to be set to 'X' in BW.

The interval of vendor is managed in Global Filter (C_GLBFILT). Currently P000000000 to PZZZZZZZZZ

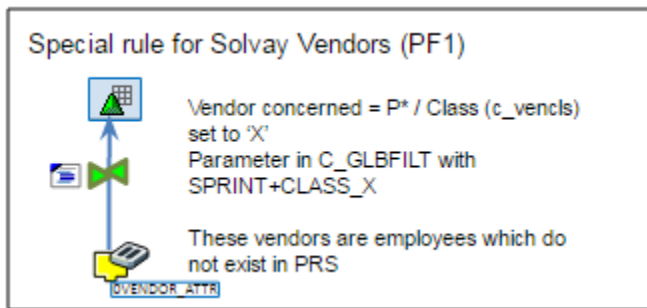

Masterdata RULE2 on Realigned Material Group (C_MATPUR2)

All realigned material group are existing on Solvay, descriptions are then filled from PF1 only. Only english description are required.

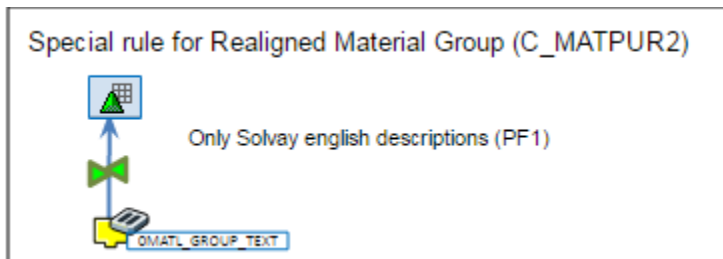

Masterdata RULE3 on Terms of Payment (C_PMNTTRM)

Terms of Payment on SAP side are managed into 2 tables. TVZBT for sales (customers), T052U for purchasing (vendor).

Payment terms can be common. On BW there is only one object for Payment Terms. T052U has to be loaded first. The description of common terms will be then TVZBT's one.

Note that keys are different, no matters, the last description is kept.

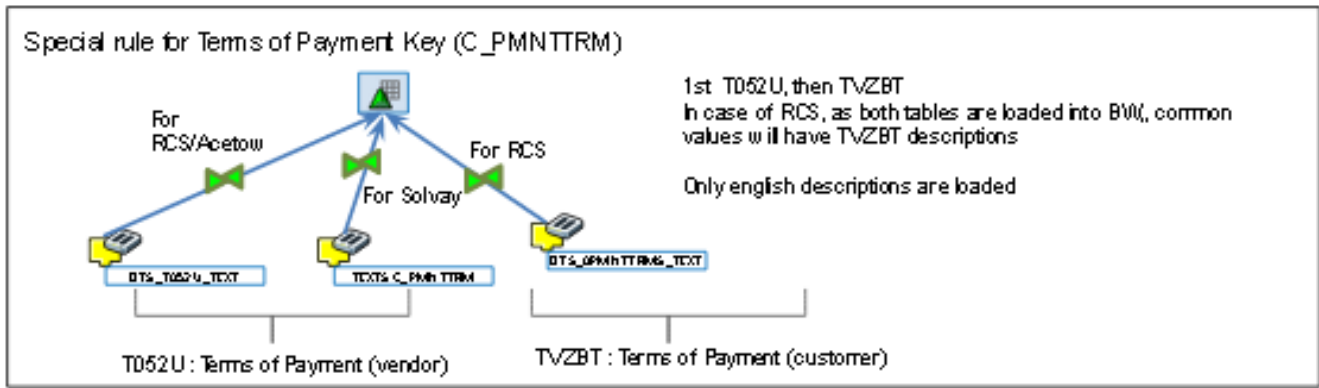

Payment terms can be find at different level

Different objects are used Sprint vs DPO, but values are the same.

(xxxx) means it comes from ECC table xxxx, otherwise it is in the document itself

	SPRINT	DPO
Vendor / Company Code view (LFB1)	C_VENDCOM__0PMNTTRMS	C_VENDCOM__C_PMNTTRM
Vendor / Purchasing view 1 (LFM1)	C_VENDPRG__C_PMNTTRM	C_VENDPRG__C_PMNTTRM
Vendor / Purchasing view 2 (LFM2)	C_PO_ITM__C_PMNTTRM2	C_VENPRG2__C_PMNTTRM
In Purchase Order (PO)	C_PO_ITM__C_PMNTTRM	C_PO_ITM__C_PMNTTRM
In Accounting Document (DOCT)	C_PMNTTRM	C_PMNTTRM

ReadSoft DataFlow

SPRINT - Data Mapping - Read Soft https://drive.google.com/file/d/1HHvjZIL3L8BJAKKQe6fx5o_RqrAuNA8tMS2Y-c2Sfk8/view

There are some differences between rhodia and solavy data flow.

For example, in function module of extractor ZFM_BW_COCKPIT_THDR, in WP1 (Rhodia), the date of rejection (ZWDATE_REJECT) is recovered in table /cockpit/thdr.

It's not the case in PF1 (Sokvay), here ZWDATE_REJECT get the date in /COCKPIT/THDR-CH_TIMESTAMP when STATUS = 13 (this rule will may be applied in Rhodia in the future).

In bw, in transformation between dso DP_RDSF and DB_RDSF, some fields like accounting doc number, posting date, controlling area... come from FIAP.

For Rhodia side, we used DSO DBFIAP01 to take data. For Solvay we used two dso: DPFIAP02 and DB_FIAP2.

Infopackages for datasources, are in delta mode. The delata is based on change date (the change date is also implemented when it's a creation of cockpit document).

WBS determination reading Settlement Rules

This rule concerns only RCS & Solvay FIAP data (transformation between DBFIAP01/2 et DB_FIAP1/2). Acetow is not concerned.

The Settlement rules (table COBRB) are loaded every days by another application (RCS : Dso DSRCOBRB / Solvay : Dso DSSCOBRB).

Reuse of rule between ODS_PMEN to DBFICS02.

Case WBS element is already determined for the FIAP record => keep it, no further determination.

Case WBS element is empty and CO order is filled => read settlement rules

First check is a previous determination has been done (lookup on Dso)

=> If yes, take the WBS element stored

=> if no, read settlement rules

The check is done to avoid duplicates as the WBS element is part of the key, and settlement rules can be changed even for the past.

NB: the check can be skip for performance purpose essentially (case of an initialization for example) => Flag in Global Filter SPRINT/DB_FIAP1 or DB_FIAP2/ put Y in low value and Y. Do not forget to put it back to N afterwards.

NB : In case of a reload of the DSO, the first WBS Element determination is lost, as the DSO is previously is emptied. The WBS Element will be the one corresponding to the current settlement rules

To see Settlement rules on ECC side :

-> use transaction KO03 with Co Order 000010528547 (for WP1)

-> button 'Settlement rule'

How COBRB table is read

=> Read only line Category WBS

=> Use firstly Settlement Type 'PER', then, if not found or out of validity, use 'GES'

=> Use firstly the higher % Settlement percentage rate

Segmentation Segment/Domain/Cost Sub Package/Cost Package/Cost Macro Package

Since 2020, with projects S3 and co\$ta, the Segmentation rule was changed.

Until then it was based on Vendor Segmentation: Domain and Segment come from 1. domain/segment of the Vendor if assigned; if not, 2. domain /segment of the Creditor if assigned; if not, 3. domain/segment of the PO Material Group; Exceptions: if the domain of the Creditor is "LO - Logistic (8)" and domain of the Vendor is different, take domain/segment of the Creditor.

With S3 and co\$ta it was changed to focus on Material Group Segmentation.

There are two kind of rules, simplified and complete.

The simplified rules, based on the rules below, determine only the Segment and the Domain.

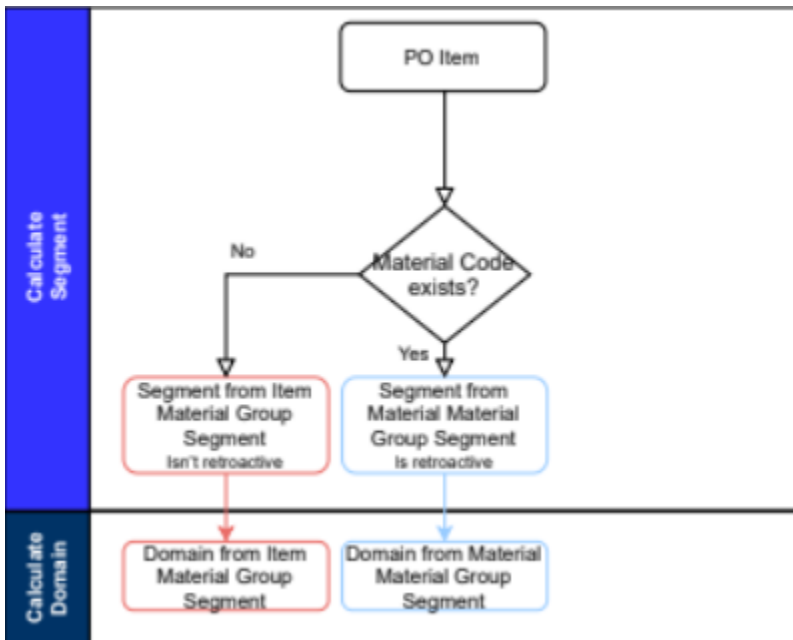

The simplified rules are determined in the following transformations:

- TRSF: DPMMC01 -> DBMMC01 (PC_FILE)
- TRSF : DP_PUCS1 -> DB_PUCS1 (Rhodia)
- TRSF : DP_PUCS2 -> DB_PUCS2 (Solvay)
- TRSF : DB_PUDC1 -> DB_PUDC1 (Rhodia - Domain/Segt/GBU)
- TRSF : DB_PUDC2 -> DB_PUDC2 (Solvay - Domain/Segt/GBU)
- TRSF : DB_PUHD1 -> DB_PUHD1 (Rhodia - Domain/Segt/GBU)
- TRSF : DB_PUHD2 -> DB_PUHD2 (Solvay - Domain/Segt/GBU)
- TRSF : DP_PUSL1 -> DB_PUSL1 (Rhodia)
- TRSF : DP_PUSL2 -> DB_PUSL2 (Solvay)
- TRSF : DB_PUSL1 -> DB_PUSL1 (Rhodia - Domain/Segt/GBU)
- TRSF : DB_PUSL2 -> DB_PUSL2 (Solvay - Domain/Segt/GBU)

The complete rules, based on the rules below, determine the Segment, the Domain, the Cost Sub-Package, the Cost Package and the Cost Macro Package.

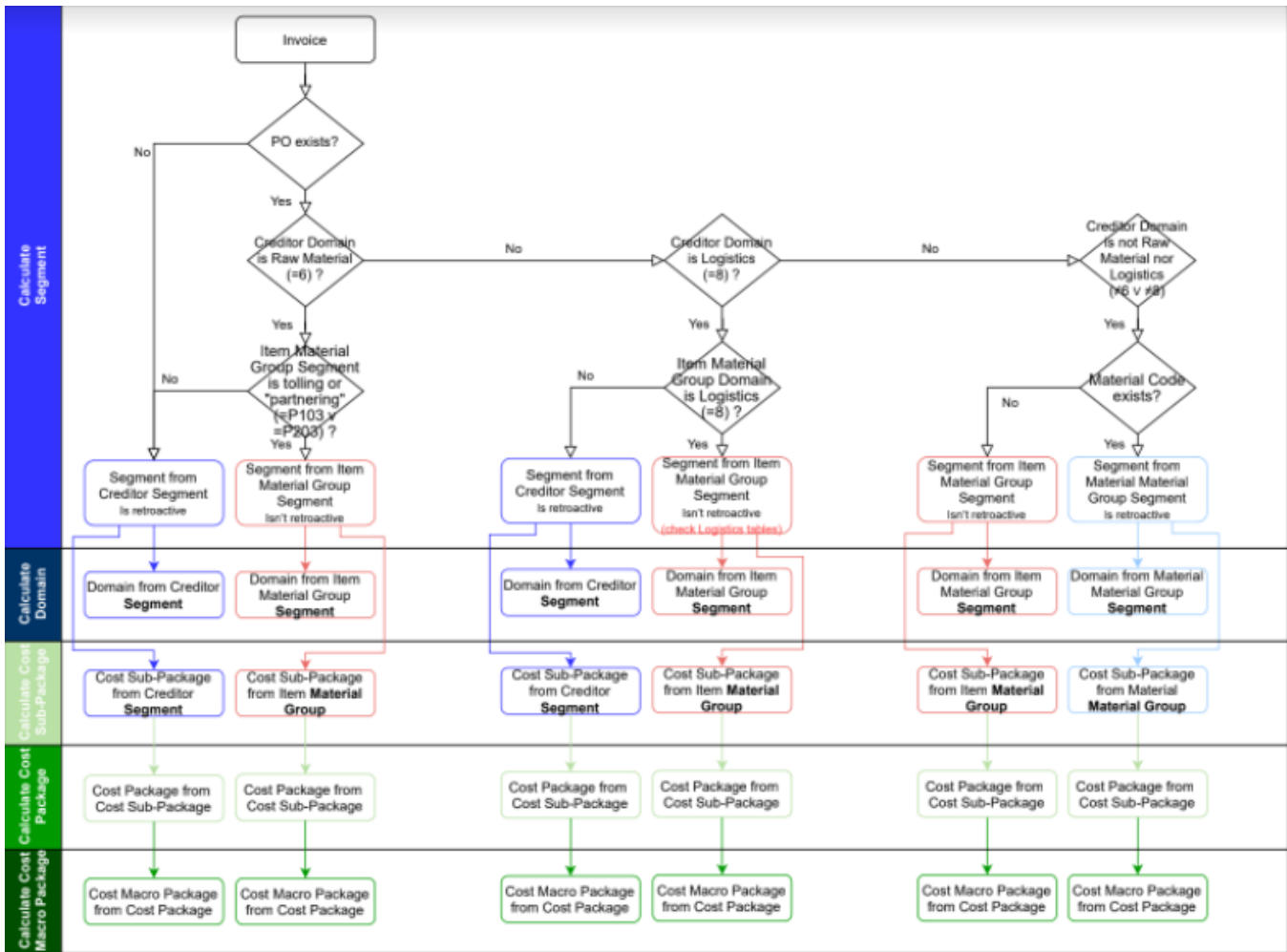

The complete rules are determined in the following transformations:

- TRSF : DBFIAP01 -> DB_FIAP1 (Rhodia)
- TRSF : DB_FIAP1 -> DB_FIAP1 (Rhodia - Domain/Segment)
- TRSF : DBFIAP02 -> DB_FIAP2 (Solvay)
- TRSF : DB_FIAP2 -> DB_FIAP2 (Solvay - Domain/Segment)

Loadings

There is a daily loading for the following transformations that works in delta mode:

- TRSF : DPMMCY01 -> DBMMCY01 (PC_FILE)
- TRSF : DP_PUCS1 -> DB_PUCS1 (Rhodia)
- TRSF : DP_PUCS2 -> DB_PUCS2 (Solvay)
- TRSF : DP_PUSL1 -> DB_PUSL1 (Rhodia)
- TRSF : DP_PUSL2 -> DB_PUSL2 (Solvay)
- TRSF : DBFIAP01 -> DB_FIAP1 (Rhodia)
- TRSF : DBFIAP02 -> DB_FIAP2 (Solvay)

The segmentation is redetermined every Sunday. There is a weekly loading for the following transformations that works in full mode with two abap filters in the data transfer process that determine the source system and the period that is current year and previous three years (see global filter C_GLBFLT / SPRINT / SEGMENTAT):

- TRSF : DPMMCY01 -> DBMMCY01 (PC_FILE)
- TRSF : DB_PUDC1 -> DB_PUDC1 (Rhodia - Domain/Segt/GBU)
- TRSF : DB_PUDC2 -> DB_PUDC2 (Solvay - Domain/Segt/GBU)
- TRSF : DB_PUHD1 -> DB_PUHD1 (Rhodia - Domain/Segt/GBU)
- TRSF : DB_PUHD2 -> DB_PUHD2 (Solvay - Domain/Segt/GBU)
- TRSF : DB_PUSL1 -> DB_PUSL1 (Rhodia - Domain/Segt/GBU)
- TRSF : DB_PUSL2 -> DB_PUSL2 (Solvay - Domain/Segt/GBU)
- TRSF : DB_FIAP1 -> DB_FIAP1 (Rhodia - Domain/Segment)

- TRSF : DB_FIAP2 -> DB_FIAP2 (Solvay - Domain/Segment)

Cost Package mapping

C_MAT_GRP (Material Group) through WEBDYNPRO ZWD_FILE_C_MAT_GRP_SEGT.

The webdynpro ZWD_FILE_C_MAT_GRP_SEGT loads into C_MAT_GRP the following master data fields:

- LOGSYS (Source System)
- C_MAT_GRP (Material group)
- C_MAT_PUR (Material Group Purchasing (Obsolete))
- C_SEGT (Segment code)
- C_CTMCPKG (Costs Macro-Package)
- C_CTPKG (Costs Package)
- C_CTSBPKG (Costs Sub-Package)

The source system of the above webdynpro is an excel file that is moved into the folder "/usr/sap/tmp/C_MAT_GRP_SEG.csv" of the transaction AL11 and from there into C_MAT_GRP.

Segment

There are two daily loadings, from Monday to Friday:

1. loads data based on the data source DTS_BW_ZZRSEGT_ATTR from PRS_020
2. loads data from C_SEGT to C_SEGT and takes result of C_CTPKG (Costs Package) and C_CTSBPKG (Costs Sub-Package) from C_MAT_GRP (Material Group) if not fed from DTS_BW_ZZRSEGT_ATTR

Organization (P)

Organization (P), C_ORG attribute of 2 Function, C_FUNCT_2.

C_ORG is a non-navigation attribute of C_FUNCT_2.

Characteristic	C_FUNCT_2						
Long Description	2 Function						
Short Description	2 Function						
Version	<input checked="" type="checkbox"/>	Active	<input type="checkbox"/>	Saved			

General Business Explorer Master Data/Texts Hierarchy Attributes

Delete Master Data with 0recordmode Navigation Att

Attributes: Detail/Navigation Attributes

Attribute	Ver...	Long Description	Ty.	Tim...	Ind...	Ord...	Na...
C_ORG	<input checked="" type="checkbox"/>	Organization (P)	DIS	<input type="checkbox"/>	<input type="checkbox"/>	0	

and such Master Data is used in order to determine C_ORG into the two DSOs DB_FIAP1 and DB_FIAP2.

That Master Data is loaded through PC_FILE Data Source on a Business request and triggered by the Process Chain PC_SPEND_S3_01.

2 Function	InfoObjects
2 Function (Attributes)	InfoProviders
RSDS DTS_C_FUNCT_2_ATTR PC_FILE -> IOBJ C_FUNCT_2	DataSources
DTS_C_FUNCT_2_ATTR	PC_FILE
IP: DTS_C_FUNCT_2_ATTR -> C_FUNCT_2	DataSources

The description of C_ORG comes from two different Data Sources, from WP1_400 for the GBU description and from PC_FILE for the Organization (P).

Organization (P)	InfoObjects
Organization (P) (Texts)	InfoProviders
TRSF: DTS_C_ORG_TXT -> C_ORG	DataSources
DTS_C_ORG_TXT	PC_FILE
IP: DTS_C_ORG_TXT -> C_ORG	DataSources
TRSF: DTS_ZWFAT212 -> C_ORG	DataSources
ZWFAT212 GBU Extractor	WP1_400
Data Transfer Processes	
DTP: DTS_C_ORG_TXT -> C_ORG	
DTP: DTS_ZWFAT212 -> C_ORG	

The schedule of the loading from WP1_400 is 7 times per day excluded the weekend and it is triggered by the Process Chain FREQUENTLY_LOAD_MD.

03.06.2020
06 : xx o'clock
10 : xx o'clock
12 : xx o'clock
14 : xx o'clock
16 : xx o'clock
18 : xx o'clock
22 : xx o'clock

The schedule of the loading from the PC_FILE is on a Business request and triggered by the Process Chain PC_SPEND_S3_01.

C_ORG is used into the following objects.

Organization (P)	C_ORG
InfoCube	
FIAP for SPRINT (Rhodia)	CR_PUAP1
FIAP for SPRINT (Solvay)	CR_PUAP2
Query Element	
SPRINT - PUR: Spend Analysis (Core Query)	BW_QRY_MV_SPD01_0004
SPRINT - PO/Spend Analysis	MV_SPD01
DataStore Object (Classic)	
FIAP for SPRINT (Rhodia)	DB_FIAP1
FIAP for SPRINT (Solvay)	DB_FIAP2

Into the two following Transformations

FIAP for SPRINT (Rhodia)	InfoProviders
TRSF : DBFIAP01 -> DB_FIAP1 (Rhodia)	
FIAP : Line Item Splitted with Delta - Rhodia Level 2	InfoProviders

FIAP for SPRINT (Solvay)	InfoProviders
TRSF : DBFIAP02 -> DB_FIAP2 (Solvay)	
FIAP : Line Item Splitted with Delta - Solvay Level 2	InfoProviders

it is mapped in the Rule Routine

Routine Organization (P)	118	C_ORG	Organization (P)
--------------------------	-----	-------	------------------

based on the following Business Rules:

If C_SUBACT2__CPFCTR1_2 <> "CB" -> C_ORG = C_SUBACT2__CPFCTR1_2

Else

If C_SUBACT2__CPFCTR1_2 = "CB" And C_CALRCC__C_FUNCT_2 Is Empty -> C_ORG = C_SUBACT2__CPFCTR1_2

Else

If C_SUBACT2__CPFCTR1_2 = "CB" And C_CALRCC__C_FUNCT_2 Is Not Empty --> C_ORG = C_FUNCT_2__C_ORG



Into the two following Transformations

FIAP for SPRINT (Rhodia)	InfoProviders
TRSF : DB_FIAP1 -> CR_PUAP1 (Rhodia)	
FIAP for SPRINT (Rhodia)	InfoProviders
FIAP for SPRINT (Solvay)	InfoProviders
TRSF : DB_FIAP2 -> CR_PUAP2 (Solvay)	
FIAP for SPRINT (Solvay)	InfoProviders





it is mapped one by one.

Description					
Target InfoObjct	C_ORG Organization (P)				
Rule Type	Direct Assignment				
Conversion Exit	ALPHA Perform <input type="checkbox"/>				
Transfer Routine	<input type="checkbox"/>				
Source Fields of Rule:					
InfoObject	Ic...	Long Description	Data type	Length	Conv.Ro...
C_ORG		Organization (P)	CHAR	3	ALPHA



In the Multiprovider MV_SPD01 it is identified with the two cubes CR_PUAP1 and CR_PUAP2.

InfoObject	C_ORG	 
Long Description	Organization (P)	
Reference InfoObject	C_ORG	
Assignment for:		<All Involved Providers>

Identification of Characteristic/Navigation Attr.

	InfoProvider	Dimension		InfoObject/Nav.Attr.	Description
	FIAP for SPRINT (Rhodia)	 Organization	<input checked="" type="checkbox"/>	C_ORG	Organization (P)
	FIAP for SPRINT (Solvay)	 Organization	<input checked="" type="checkbox"/>	C_ORG	Organization (P)

The loading of the Master Data of C_FCUNCT_2 and of the Description of C_ORG, based on a Business request, is triggered by the Process Chain PC_SPEND_S3_01.

	148 - PROJECT - S3: Reporting Tool	COMP_SPEND
	S3: Reporting Tool	PC_SPEND_S3_01

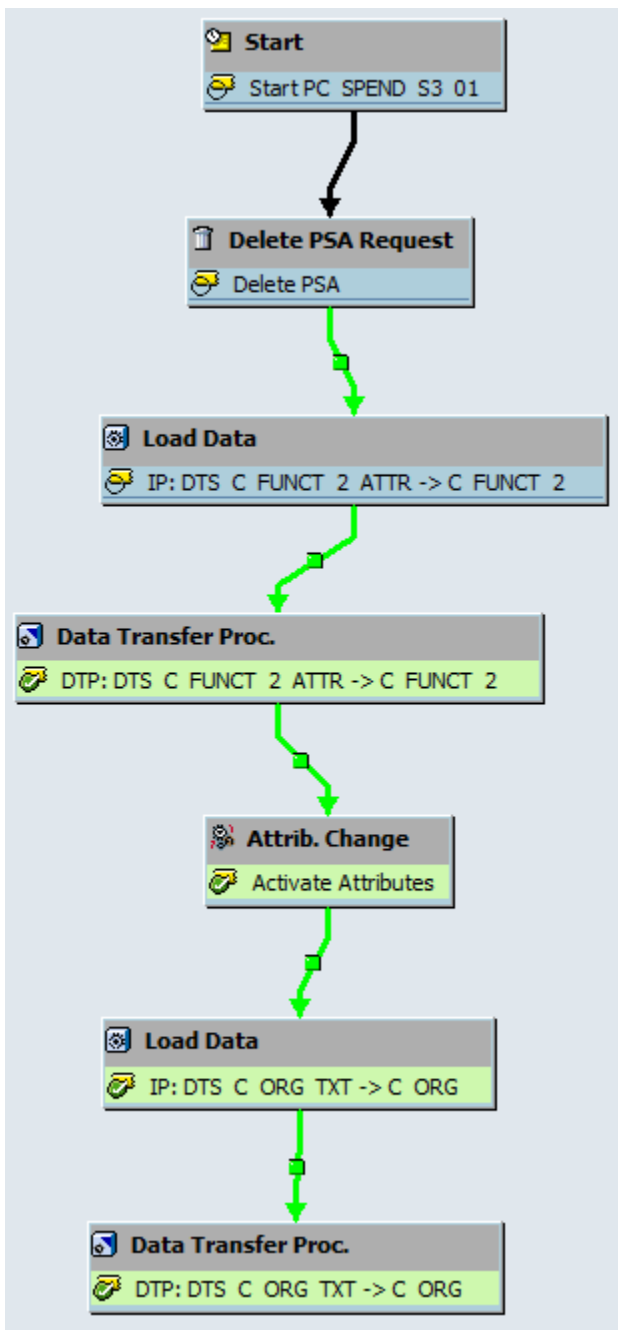

Specific procedure for the historical re-loading of the Organization (P).

After having run the Process Chain PC_SPEND_S3_01 it needs to re-determine C_ORG into SPRINT flow, meaning into DB_FIAP1 à CR_PUAP1 and into DB_FIAP2 à CR_PUAP2.

The complete procedure to re-load all is the following.

When receiving the Freshdesk ticket from the Business, you have to save the two files (one for C_FUNCT_2 attributes and one for C_ORG descriptions) in your local computer.

The two files have to have the following layout:

C_FUNCT_2 attributes

FUNCTION CODE	ORGANIZATION CODE
ZCBS-CGP	CBG
ZCBS-CHR	CBH
ZCBS-CIA	CBJ
ZCBS-CIAM	CBJ
ZCBS-CIND	CBI

C_ORG text

ORGANIZATION CODE	ORGANIZATION TEXT
CBA	INTERNAL AUDIT AND RISK MANAGEMENT
CBC	COMMUNICATIONS
CBD	SUSTAINABLE DEVELOPMENT
CBF	FINANCE
CBG	GOVERNMENT AND PUBLIC AFFAIRS

Then into the two following InfoPackages

catch the two files saved during the previous step.

Then, run manually the Process Chain PC_SPEND_S3_01.

Once the Process Chain is finished, perform the following manual steps:

For SPRINT Rhodia

- Delete data manually in DB_FIAP1 for the period asked in the Freshdesk ticket

FIAP for SPRINT (Rhodia)

- Run manually a FULL loading from DBFIAP01 to DB_FIAP1 filtered for the period deleted at point 1 and activate data

FIAP for SPRINT (Rhodia)
 TRSF : DBFIAP01 -> DB_FIAP1 (Rhodia)
 FIAP : Line Item Splitted with Delta - Rhodia Level 2

- Run manually a FULL loading from DBFIAP05 to DB_FIAP1, through IFS_DBFIAP05__DB_FIAP1, filtered for the period deleted at point 1 and activate data

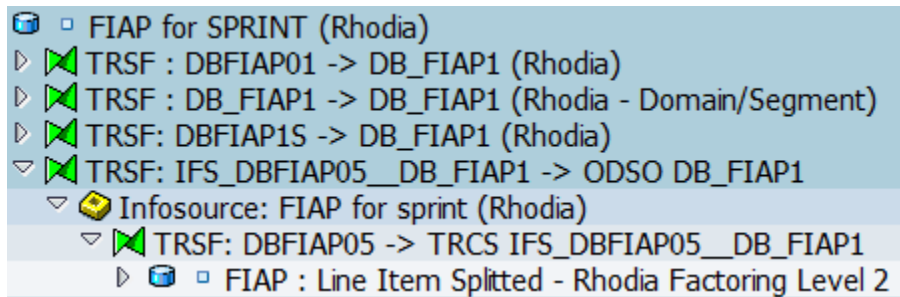

- Run manually a DELTA loading from DB_FIAP1 to DB_FIAP1, through IFS_DB_FIAP1_DB_FIAP1 and activate data

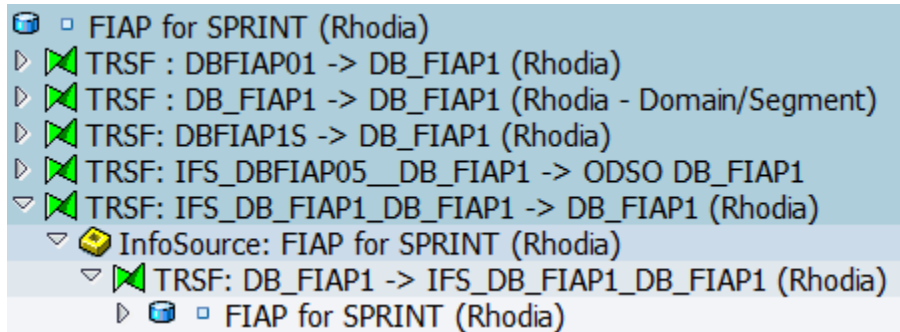

- Delete data manually in CR_PUAP1 for the period asked in the Freshdesk ticket

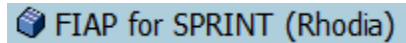

- Run manually a DELTA loading from DB_FIAP1 to CR_PUAP1

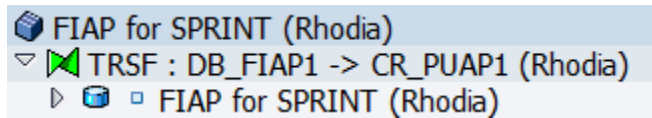

For SPRINT Solvay

- Delete data manually in DB_FIAP2 for the period asked in the Freshdesk ticket

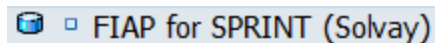

- Run manually a FULL loading from DBFIAP02 to DB_FIAP2 filtered for the period deleted at point 1 and activate data

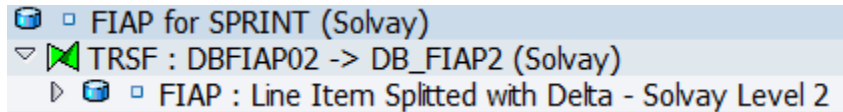

- Run manually a FULL loading from DBFIAP06 to DB_FIAP2, through IFS_DBFIAP06__DB_FIAP2, filtered for the period deleted at point 1 and activate data

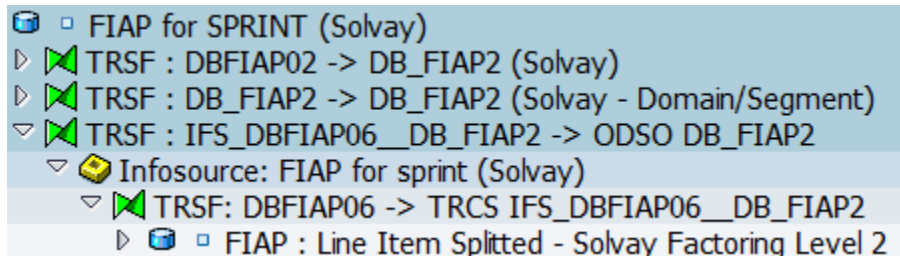

- Run manually a DELTA loading from DB_FIAP2 to DB_FIAP2, through IFS_DB_FIAP2_DB_FIAP2 and activate data

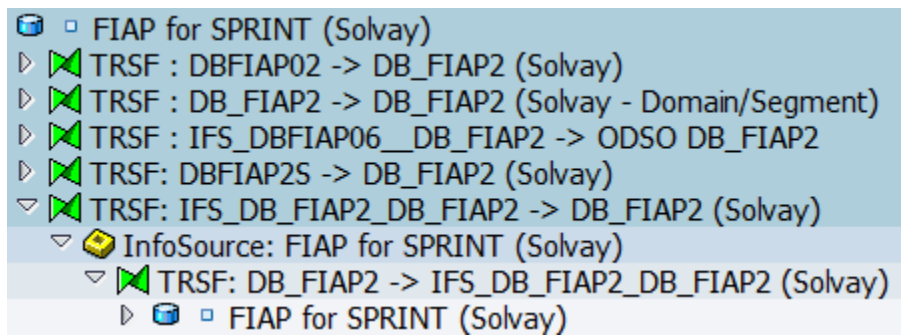

- Delete data manually in CR_PUAP2 for the period asked in the Freshdesk ticket

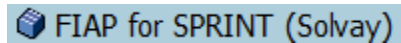

- Run manually a DELTA loading from DB_FIAP2 to CR_PUAP2

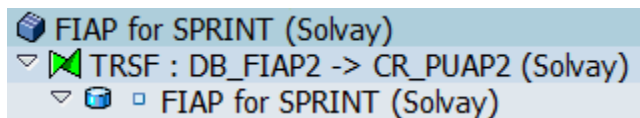

LeadTime

Lead Time <https://drive.google.com/file/d/1ZfGsiEaeqTCqopl306Om2MwLsp13SN6/view>

Calculation of compliance delta and flag for FIAP dso

In end routine of transformations for DSOs "FIAP for SPRINT" Rhodia and Solvay (DB_FIAP1 & DB_FIAP2) from splitted DSOs, there is abap code to calculate the compliance flag and eventually the delta value between payment term reference and payment term.

There is also specific transformations to reload only the compliance flag, compliance value and terms of payment key reference. These transformations can be used for historical reloading.

FIAP for SPRINT (Rhodia)	DB_FIAP1
TRSF : DBFIAP01 -> DB_FIAP1 (Rhodia)	0C02KY8T6CZJLA20TP8SEPGO1MNB9U6E
TRSF : DB_FIAP1 -> DB_FIAP1 (Rhodia - Domain/Segment)	0GWLMY07B2LV6EANCM81NRUE6MLITRUC
TRSF: IFS_DBFIAP05__DB_FIAP1 -> ODSO DB_FIAP1	0P288QHYZUIVDC5E5NX5S9T2OUQ5JA2L
TRSF: IFS_DB_FIAP1__DB_FIAP1 -> DB_FIAP1 (Compliance)	0KQJ10ST6WCZ9KS9FCRK3CGQM2MVGJTI
Infosource: FIAP for Sprint (Rhodia) - Compliance Calc	IFS_DB_FIAP1__DB_FIAP1
TRSF: DB_FIAP1 -> IFS_DB_FIAP1__DB_FIAP1 (Compliance)	0QQY5XNY9724K8MJY7V20FDDRR5YYHUR
Data Transfer Processes	DB_FIAP1
Data Flow Upwards	_DATAFLOW_UPWARDS
FIAP for SPRINT (Solvay)	DB_FIAP2
TRSF : DBFIAP02 -> DB_FIAP2 (Solvay)	06RY85RKA TBPJA788ON2QWV4L4W6SLVV
TRSF : DB_FIAP2 -> DB_FIAP2 (Solvay - Domain/Segment)	060F24XZRO82QK787HV4CY4Z9UI5K33V
TRSF : IFS_DBFIAP06__DB_FIAP2 -> ODSO DB_FIAP2	0KM2YVDQNMS5IFEP6CW52SHPJ2THD4J6
TRSF: IFS_DB_FIAP2__DB_FIAP2 -> DB_FIAP2 (Compliance)	05VQSJLFTNXDOIP6HXNN1T78UFA0ILAK
Infosource: Fiap for SPEND (Solvay) - Compliance calc	IFS_DB_FIAP2__DB_FIAP2
TRSF : DB_FIAP2 -> IFS_DB_FIAP2__DB_FIAP2 (Compliance)	07BGVM4KC8SAB32EV7XQ80XDO6I12AGP

To understand the rules and abap code, see this diagram:

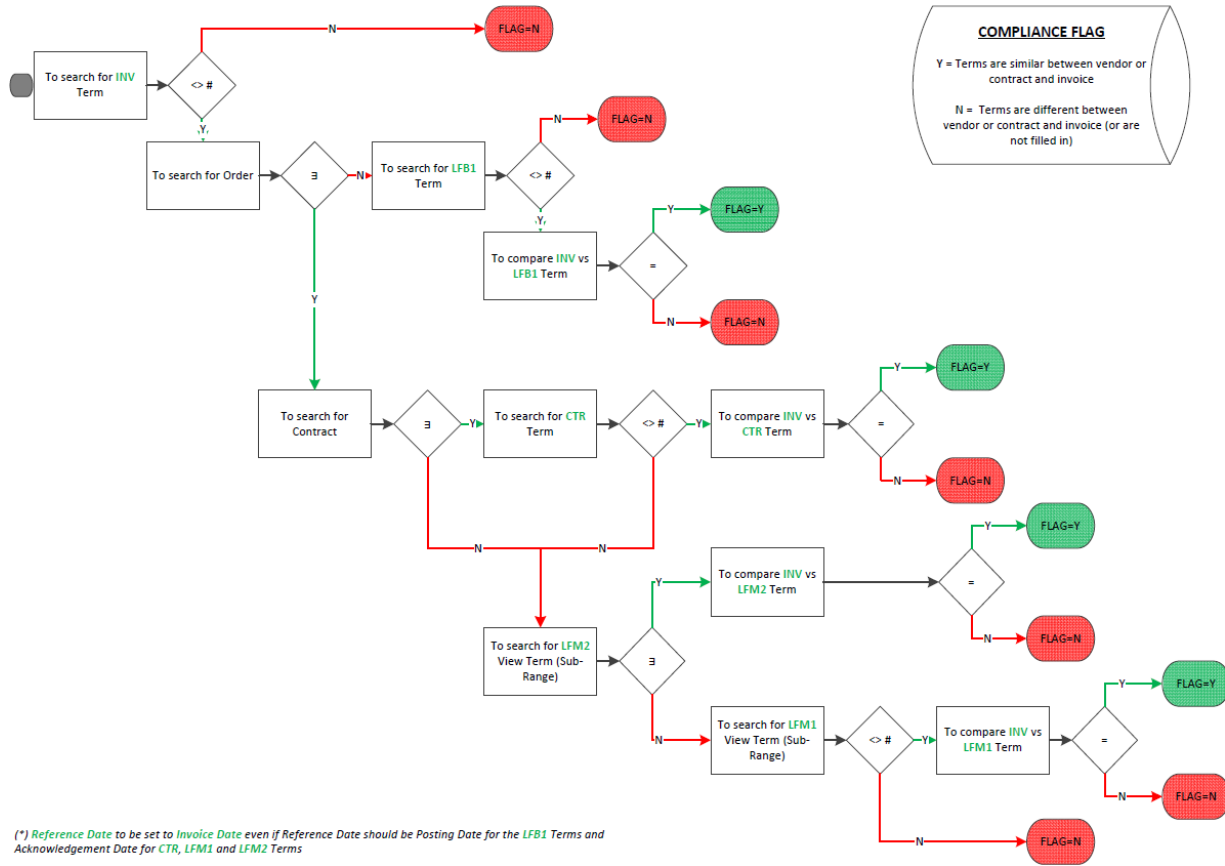

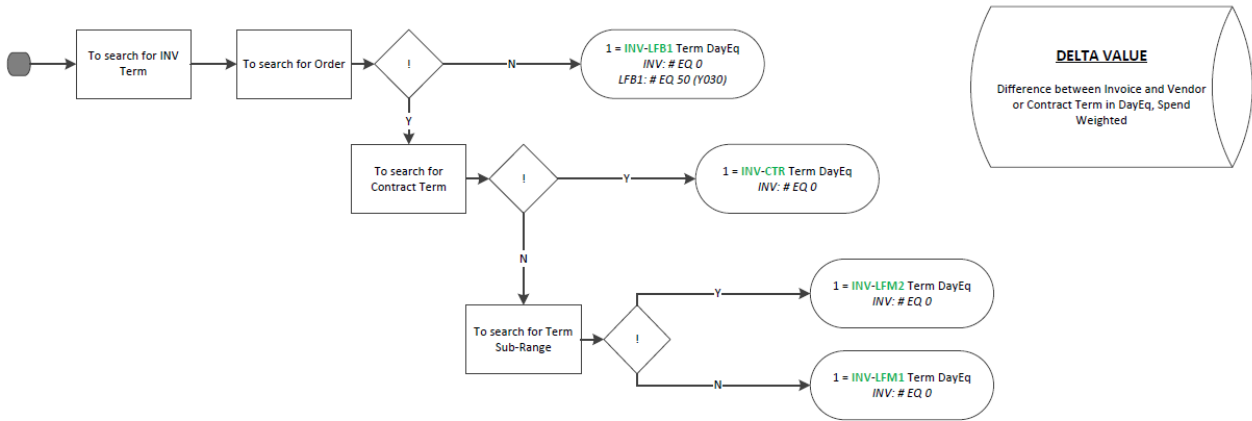

(*) Reference Date to be set to Invoice Date even if Reference Date should be Posting Date for the LFB1 Terms and Acknowledgement Date for ORD, CTR, LFM1 and LFM2 Terms

Link: <https://drive.google.com/file/d/1IEf0tJvHxy5YKZ3VeMUJFFjw1Uf4a/view>

Material Group (C_MAT_GRP)

The material group can be found at different places:

- masterdata C_MATNR2 : loaded via datasource 0MATERIAL_ATTR.
- masterdata C_PO_ITM : loaded via datasource DTS_BW_PO_ITM.
Special rule "Logistic tables" for Item Category 9 "Service" (EKPO-PSTYP) or empty material group (EKPO-MAKTL) moved from ECC to BW side (Transformation C_PO_ITM C_PO_ITM).
Also there is a Material Group "Restatement" process via custom extractor DTS_BW_GPS_EKPOREST.
- Schedule line Dsos/Cubes : load via 2LIS_02_SCL, extended. Caution same special rule, but Abap coded slightly differently => **DO NOT use it**, material group is not always correct.
- FIAP Dsos/Cubes : a lookup is done on Business level of Schedule line => **DO NOT use it**, material group is not always correct.

Caution: In case of C_PO_ITM manual data reloading via DTS_BW_PO_ITM, you **MUST** run also the Logistic Table and Restatement loadings.

- 1) Reloaded data via DTS_BW_PO_ITM;
- 2) Logistic Tables: Run C_PO_ITM C_PO_ITM for the same documents reloaded in the STEP 1;
- 3) Restatement: Extract the full PSA from DTS_BW_GPS_EKPOREST and load RSDS DTS_BW_GPS_EKPOREST (Source System) -> IOBJ C_PO_ITM.

Usage of ECC tables:

Logistic Tables

- Z1M_BW_MAT_GRP for Solvay PF1
- ZWPUT042 for RCS WP1 and Acetow RHO

https://drive.google.com/file/d/15EkoJ6OIzcSUMTrTCKjii1HGZLPr429k3_xGG692Qq4/view

Restatement Tables

- ZM_GPS_EKPOREST for Rhodia WP1 and Solvay PF1

<https://drive.google.com/file/d/1YNvzNO3w0tAu9MbJdX9VIYYX-EHHD6x1WsVkh4Gzlzo0/view>

Important : The Material Group in schedule line and FIAP Dsos & Cubes is partly false.

Currently Core & QV queries is using C_MAT_GRP from FIAP or Schedule lines. It has to be changed with C_PO_ITM attribut when Business validates it.

- **Solvay cases** (the list might be not exhausted)
 - Issue for S1.2009
Example PO 4511000082/1340 => Document date 31.03.2009 => FI document 6311201583/5835/2015
Only one part of PO for S1.2009, having a schedule line over 2013 have been loaded into BW. On may 2015 initialization, the PSA was not well loaded, and no action have been done to correct it, so part of S1.2009 is missing. No correction have yet been done as Business DSO for schedule line is using ratio in addition, and a whole re-initialization would take several weeks.
 - PO with schedule line previous to 2013 but in actual FI documents
Example PO 3100441596 => document date 09.07.2012 => Good Receipt / MM Invoice en 2012 => FI document 6311603854 / 5782 / 2015. These PO have not been loaded into BW. The FI documents do not have PO information.
 - Deleted PO items
Example PO 3100578083/20 => 2 FI documents created (6311642636/0292/2014 and 6311644101/0292/2015) before the PO item deletion the 22.12.2015.
The deleted PO items are not kept into BW (0PROCESSKEY non kept between Propa & Business DSOs). The FI documents have been reloaded several times in 2016. As the PO item is not existing anymore in the business DSO, the FIAP document can not be filled with PO information
 - Shipment Cost Number archived or other for service PO
Example PO 4502271249
PO 4502271249 => entry sheet 1005459308 => Shipment Cost 2164736
This PO has had a determined material group 0433 when the Shipment Cost was existing on WP1 (table VF KP)
Today the shipment 2164736 can not be displayed anymore in WP1, so is not existing anymore in table VF KP. Are the shipment costs archived at anytime? et just deleted some how?
The material group can not be determind any more when the PO schedule line was loaded again when the invoices were created the 02 /05/2016

The material group is also available in masterdata C_PO_ITM.
For this PO 4502271249, the material group is 0433. No modifications on the PO have been detected, so no additional loading even when the invoices were created. The material group remains 0433. **Caution**, if the masterdata C_PO_ITM is reloaded today, the material group would be reset to empty!
 - Missing combination in table ZWPUT042
Example 4502642333. Empty also in masterdata C_PO_ITM as no corresponding value for 9008/12/0003 is existing in table ZWPUT042
Caution, if the combination is added in table ZWPUT042, previous PO will not be updated, and masterdata C_PO_ITM can not be fully reloaded because Shipment Costs Number are archived or deleted.**Rhodia cases** (the list might be not exhausted)

Original Material Group (C_OMATGRP)

Field to store the Material Group value before the Logistic Tables and Restatement processes.

During the Logistic Tables logic (Transformation TRSF : C_PO_ITM -> C_PO_ITM) if the Material Group (C_MAT_GRP) has a new value defined, the Original Material Group will receive the previous Material Group (C_MAT_GRP) value.

The same occurs during the Restatement processing (Transformations: RSDS DTS_BW_GPS_EKPOREST (Source System)) -> IOBJ C_PO_ITM).

Conversion rate used in reports

The conversion rate used in reports is CAR3.

Routine CTK_CAR3

Display Currency Translation Type

Obj. directory entry

Conversion Type:

Description:

Properties | **Exchange Rate** | Currency | Time Ref.

ER Determ. Using FI Modules

Exchange Rate Type: Exchange Rate base on CAR1 ref. crcy EUR

Ex. Rate Type from Var.

Dyn. Ex. Rate Determination

Exchange Rate from InfoObj.

Inverse Ex.Rate

ER Type:

Target Currency

Target Currency Selection with Translation

Fixed Target Currency

Target Currency from Variable: Order Currency Customer Exit

InfoObject for Determining Target Currency

Use in Transformation Only (InfoObject is a currency)

Use Query Key Date

Variable Time Reference:

Standard InfoObject: Calendar Year/Month

Special InfoObject

InfoSet

Documentation for Document/MasterData Modifications extractors

It concerns DSOs DB_MAGR1/2/3 for Agreements, DB_MMAT1/2/3 for Materials, DB_MVEN1/2/3/4 for Vendors

DataSources are based on Infosets

Example DTS_CHANGEDOCUMENT_ART => documentation <https://drive.google.com/file/d/1eo5gmIhkehpMIbrWCFvyQVgbbvaPhiX/view>

There is data flow to retrieve changes on Purchasing Info Record:

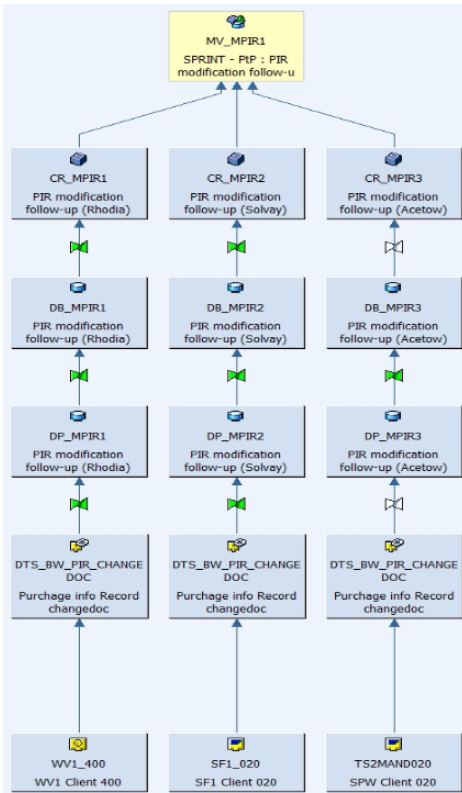

Here is the documentation:

<https://drive.google.com/open?id=0B6PYA70dlrclamRxbFlnTII4RXc>

Object	Datasources RCS	Abap Prog RCS	Datasources Solvay /Acetow	Abap Prog Solvay/Acetow	
Material	DTS_CHANGEDOCUMENT_ART	ZBW_MM_ART_CHANGEDOC	DTS_BW_CHG_MAT	ZPGR_BW_CHG_MAT	
Agreements	DTS_CHANGEDOCUMENT_CTT	ZBW_MM_CTT_CHANGEDOC	DTS_BW_CHG_AGR	ZPGR_BW_CHG_AGR	
Vendor	DTS_CHANGEDOCUMENT_VEN	ZBW_MM_VEN_CHANGEDOC	DTS_BW_CHG_VEN	ZPGR_BW_CHG_VEN	
Purchasing Info Record	DTS_BW_PIR_CHANGEDOC	ZFM_BW_PIR_CHANGEDOC (function module)	DTS_BW_PIR_CHANGEDOC	ZFM_BW_PIR_CHANGEDOC (function module)	

Master Data Attributes & Texts loaded via Web Dynpro

Web Dynpro are used for integration of some masterdata informations :

- Change immediately information before updates are done in PRS, and afterwards loaded into BW
- Manage information which are not managed in other systems

Users are then autonomous to update BW masterdata (creation of flat file / check of the flat file / upload of the flat file / status of the execution of the associated process chain)

Web dynpro documentation is available in following directory: https://drive.google.com/drive/folders/1JHeLUAE_Js_OBgEjaE6BkUHBj4mHw3YM

- user documentation
- technical documentation

The flat files to load have to follow rules to be uploaded into BW. See https://drive.google.com/file/d/15vd01-rTmtbvFAAJ93HJ9g0t_trLXa28J61U5xvETq8/view

The user interface is available in Solia portal.

See user documentation https://drive.google.com/file/d/1hXc4s5sITM6PcX86qKQiyj-LbbJj64_2jhJBL18ROs/view

Currently, only Sylvie Sévérini has the access. The technical team do not have access. Tests have to be done via SE80.

Contact person for any issue on Portal / Sprint menu : **Reiner Hellstern** (person who has replaced José Cervera)

Documentation to make transport in java portal: [How to release/transport Webdynpro on the Java portals](#)

Good to know: For Sprint, in java portal, the name of web dynpro are changed, there are the prefix "SPRINT -" before the name.

To change the name in java portal, it's on propriety of Iview and Workset (it's the same manipulation for both):

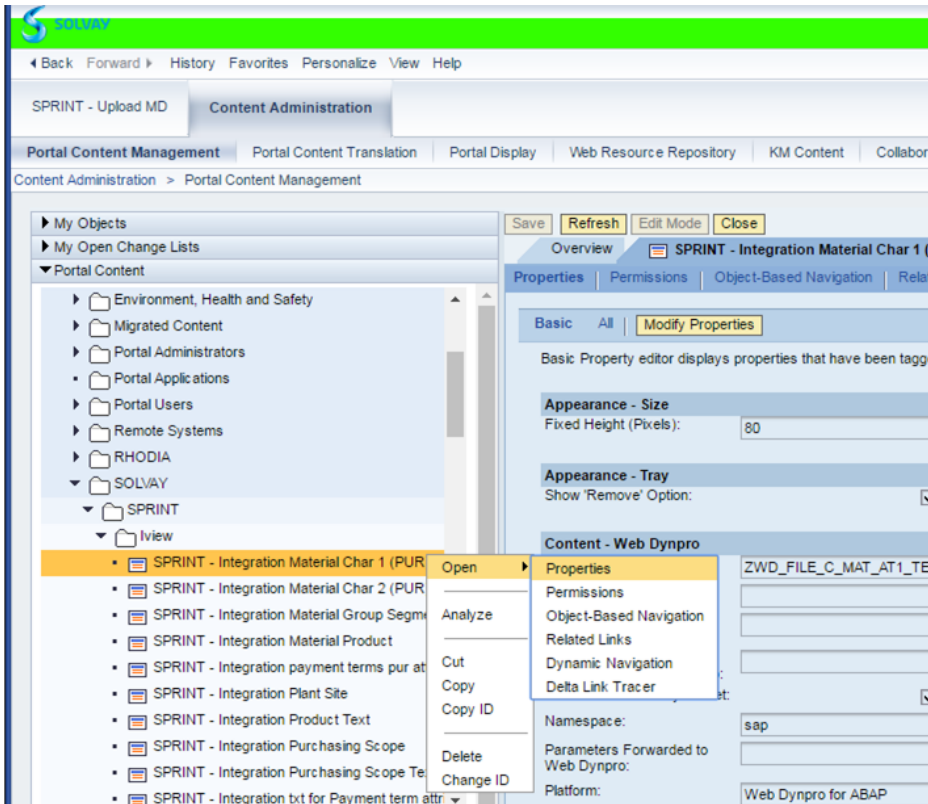

Then, go clic on "All" to have all proprieties and search propriety called "Name".

Or search directly the propriety with the research bar.

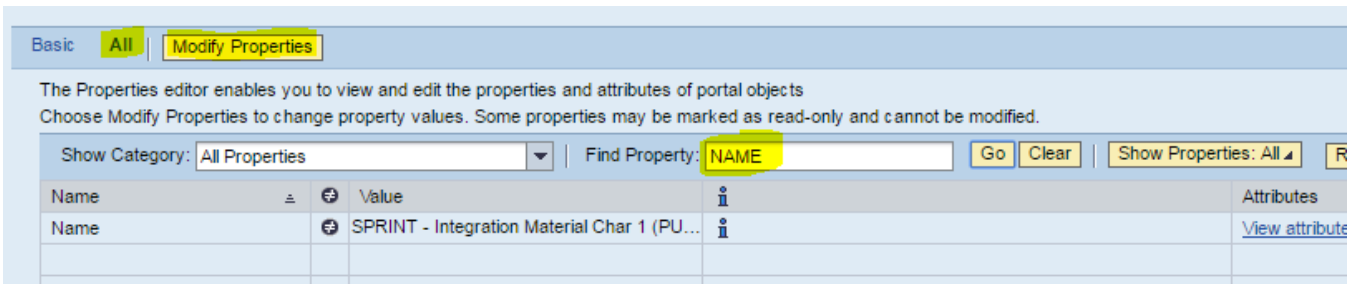

When you are in the propriety, you can add the prefix.

Loadings are managed via process chains, launched on event (See Process Chain paragraph)

Example: PC_C_VENDID_SEG / event PC_C_VENDID_SEG

Description	BW masterdata impacted	Fields impacted	Webdynpro
Integration Material Group Segment	C_MAT_GRP	Source system (Key) Material group (Key) Material Group Purchasing (Obsolete) Segment code Costs Macro-Package Costs Package Costs Sub-Package	ZWD_FILE_C_MAT_GRP_SEG
Integration Material Product	C_MATNR2	Source system (Key) Material (Key) Product (PUR) Value Chain (PUR) First Used Date Material Attribute 1 (PUR) Material Attribute 2 (PUR)	ZWD_FILE_C_MATNR2_PROD
Integration Plant Site	C_PLANT	Source system (Key) Plant (Key) Purchasing site Authorization Scope	ZWD_FILE_C_PLANT_SITE
Integration Purchasing Scope	C_COMPPRS	PRS Company code (Key) Purchasing Scope	ZWD_FILE_C_COMPPRS_PSCOPE
Integration Vendor Segment	C_VENDID	Source system (Key) Vendor number (Key) (Obsolete) DUNS - Domestic Ultimate Segment code Class Segmentation approval date Segmentation approval user	ZWD_FILE_C_VENDID_SEG
Integration Value Chain (PUR) Text	C_PRODGRP_TXT	Value Chain (PUR) (Key) Medium description	ZWD_FILE_PRODGRP_TEXT
Integration Product Text	C_PURPROD_TXT	Product (PUR) (Key) Medium description	ZWD_FILE_PURPROD_TEXT
Integration Purchasing Scope Text	C_PSCOPE_TXT	Purchasing scope (Key) Short description	ZWD_FILE_PSCOPE_TEXT
Integration Material Text attr 1 (PUR)	C_MAT_AT1	Material Attribute 1 (PUR) (Key) Medium description	ZWD_FILE_C_MAT_AT1_TEXT
Integration Material Text attr 2 (PUR)	C_MAT_AT2	Material Attribute 2 (PUR) (Key) Medium description	ZWD_FILE_C_MAT_AT2_TEXT
Integration Vendor Attributes (PUR)	C_VENDID	Source system (Key) Vendor number (Key) Vendor Attribute 1 (PUR) Vendor Attribute 2 (PUR)	ZWD_FILE_C_VENDID_ATTR

Integration Vendor Text attr 1 (PUR)	C_VND_AT1	Vendor Attribute 1 (PUR) (Key) Medium description	ZWD_FILE_C_VND_AT1_TEXT
Integration Vendor Text attr 2 (PUR)	C_VND_AT2	Vendor Attribute 2 (PUR) (Key) Medium description	ZWD_FILE_C_VND_AT2_TEXT
Integration Payment terms Attributes (PUR)	C_PMNTTRM	Source system (Key) Term of payment key (Key) Payment term attribute 1 (PUR) Payment term attribute 2 (PUR)	ZWD_FILE_C_PMNTTRM_ATTR
Integration Payment term attr 1 Text (PUR)	C_PMT_AT1	Payment term attribute 1 (PUR) (Key) Long description	ZWD_FILE_C_PMT_AT1_TEXT
Integration Payment term attr 2 Text (PUR)	C_PMT_AT2	Payment term attribute 1 (PUR) (Key) Long description	ZWD_FILE_C_PMT_AT2_TEXT
File Integration Site text	C_SITE_TXT	Site Key Language key Site txt	ZWD_FILE_C_SITE_TEXT
File Integration Vendor country	C_VENDID	Source System Key Vendid Key country	ZWD_FILE_C_VENDID_COUNTRY
File Integration Plant text	C_PLANT_TXT	Source System Key Plant Key Plant Txt	ZWD_FILE_C_PLANT_TEXT
File Integration vendid text	C_VENDID_TXT	Source System Key Vendid Key Vendid Txt	ZWD_FILE_C_VENDID_TEXT
File Integration company code text (cytec src system)	C_COMPCDE_TXT	Source System Key Company code Key Company code Txt	ZWD_FILE_C_COMPCDE_TEXT
File Integration company code Auth scp + PRS (Cytec system)	C_COMPCDE	Source System Key Company code Key PRS Company code Authorization Scope	ZWD_FILE_C_CMPCDE_PRS_AUT
File Integration Material Text	C_MATNR2_TXT	Source System Key Material Key Material Key (Text)	ZWD_FILE_C_MATNR2_TEXT
File Integration material group text	C_MAT_GRP_TEXT	Source System Key Material Group Key Material Key (Text)	ZWD_FILE_C_MAT_GRP_TEXT
File Integration DSO Company Code (Site Restated (P))	DPCOMPCD (dso)	Source System Key Company code Key Site Restated (P) Key	ZWD_FILE_DPCOMPCD

When web dynpro ZWD_FILE_C_VENDID_SEGT is used, in transformation TRSF : DTS_C_VENDID_SEG -> C_VENDID (WebDynpro), in start routine there is a verification:

If the vendor has a correspondance in master data vendor PRS, no update is possible and attributes have to manage in PRS. So the records isn't updated.

To get the url corresponding to the WebDynpro...

SE80

KeyFigures in "summation" mode

Caution Few KeyFigure are in "Summation" mode in transformations : for PO Schedule lines DSOs (DB_PUSL1/2/3), for PO History DSOs (DB_PUHD1/2/3)

Cytec data flow & procedures

Cytec FI data flow

Cytec MM data flow

BOZAR data flow & procedures (VBF)

PO2 change

In the cope of Power of 2 project, the VBF data flow and program was duplicated, a new data flow and transaction for SCO were created, the original data flow / transaction (above) are for ECO data.

We applied a physical segregation in some transformations.

To activate the segregation, in master data global filter a variable need to be activated:

Table: /BIC/PC_GLBFLT

/BIC/C_STREAM	/BIC/C_RULE	/BIC/C_GLBFLT	OBJVERS	CHANGED	/BIC/C_DESC	/BIC/C_SIGN	/BIC/C_OPTION	/BIC/C_LOW	/BIC/C_HIGH	/BIC/C_ACTIVE
BOZAR	SPLIT_SCOP	001	A		Exclude company code eco / sco in VBFs data flows	I	EQ	YES		Y

If in global filter field C_LOW = YES,

- during the loading in ECO data flow, if the segregation is activated, the data with C_AUTHMA = SCO will be excluded. The exclusion is done in start routine of transformations:
 - TRSF: ODSO DB_BOCON -> ODSO DB_BOCAL
 - TRSF: ODSO DBPUPE01 -> ODSO DBPUPE02
- during the loading in SCO data flow, if the segregation is activated, the data C_AUTHMA = ECO will be excluded. The exclusion is done in start routine of transformations:
 - TRSF: ODSO DB_BOCON -> AB_BOCAL
 - TRSF: DBPUPE01 -> ABPUPE02

Dependencies with other applications

Few DSOs are shared with FI :

- FIAP
 - DBFIAP01 - FIAP : Line Item Splitted with Delta - Rhodia Level 2
 - DBFIAP02 - FIAP : Line Item Splitted with Delta - Solvay Level 2
 - DBFIAP04 - FIAP : Line Item Splitted with Delta - Acetow Level 2
- FIGL
 - DBFIGL02 - AP from FIGL: Line Items - Rhodia Level 2
 - DBFIGL05 - AP from FIGL: Line Items - Solvay Level 2
 - DBFIGL11 - AP from FIGL: Line Items - Acetow Level 2

SPRINT New Data Flows with Advanced DSOs

The following objects have been developed:

New Objects		Existing Objects (to be replaced by the new ones)	
Type	Name	Type	Name
aDSO	"Consignment Withdrawals (Rhodia)" [ABMMPUCS1]	DSO	"Consignment Withdrawals (Rhodia)" [DB_PUCS1]
aDSO	"Consignment Withdrawals (Solvay)" [ABMMPUCS2]	DSO	"Consignment Withdrawals (Solvay)" [DB_PUCS2]
aDSO	"MM CYTEC : Material Management (PC_FILE)" [ABMMCY01]	DSO	"MM CYTEC : Material Managment (PC_FILE)" [DBMMCY01]
aDSO	"PO : Historical Data (Rhodia)" [ABPOPUHD1]	DSO	"PO : Historical Data (Rhodia)" [DB_PUHD1]
aDSO	"PO : Historical Data (Solvay)" [ABPOPUHD2]	DSO	"PO : Historical Data (Solvay)" [DB_PUHD2]
Composite Provider	"SPRINT - PO/Spend Analysis" [CPPURSPD01]	MultiProvider	"SPRINT - PO/Spend Analysis" [MV_SPD01]
Queries	"SPRINT - PUR: Spend (MM) (Core Query)" [BW_QRY_CPPURSPD01_0001] [QV_BW_QRY_CPPURSPD01_0001] [DI_BW_QRY_CPPURSPD01_0001]	Query	"SPRINT - PUR: Spend (MM) (Core Query)" [BW_QRY_MV_SPD01_0025]

A high-level overview of the Data Flows is provided in the diagram depicted below:

SPRINT – PO/Spend Analysis

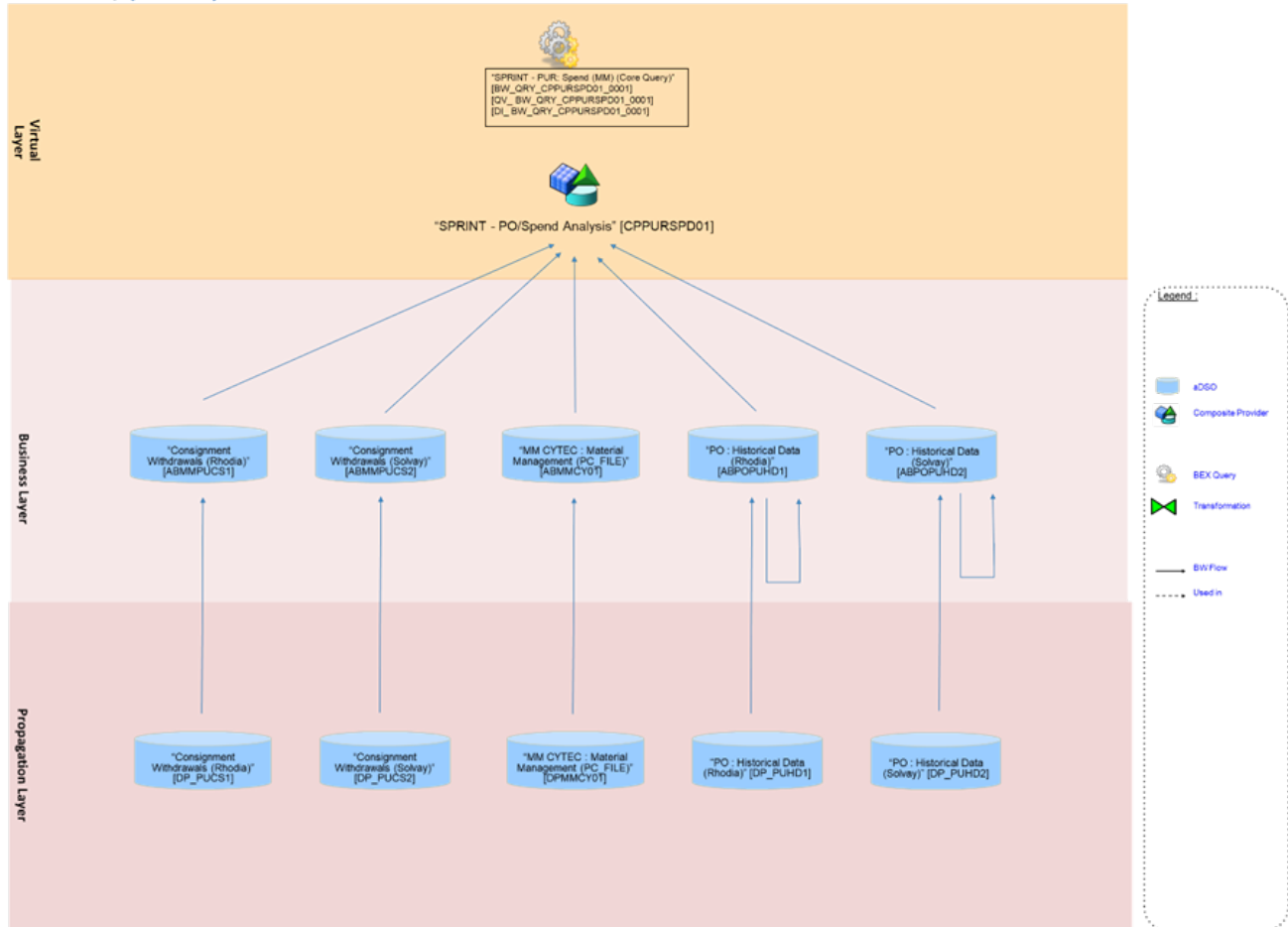

Composite Provider CPPURSPD01

The Composite Provider "SPRINT – PO/Spend Analysis" is fed from five newly developed Advanced DSOs which provide information regarding Consignments, PO Historical Data and CYTEC MM:

SPRINT - PO/Spend Analysis	CPPURSPD01
▶ Consignment Withdrawals (Rhodia)	ABMMPUCS1
▶ Consignment Withdrawals (Solvay)	ABMMPUCS2
▶ MM CYTEC : Material Management (PC_FILE)	ABMNCY01
▶ PO : Historical Data (Solvay)	ABPOPUHD2
▶ PO : historical Data (Rhodia)	ABPOPUHD1

aDSO ABMMPUCS1

The aDSO "Consignment Withdrawals (Rhodia)" is loaded from the Propagation Layer DSO DP_PUCS1:

3 - Purchasing Sprint - Schedule Line - Business Transf	IA_PUR_SPRINT_SCL_BUS_TRANSF
Consignment Withdrawals (Rhodia)	ABMMPUCS1
TRSF: IB_MM_PUCS1 -> ABMMPUCS1	0FT4XHNO60XAZUJLDCUV4FYQ00E5ED
IB_MM_PUCS1	IB_MM_PUCS1
TRSF: DP_PUCS1 -> IB_MM_PUCS1	0HAN9KFQBULUMJ7MFYESIOXCF7B9S0!
Consignment Withdrawals (Rhodia)	DP_PUCS1
Data Transfer Processes	ABMMPUCS1
DTP: DP_PUCS1 -> ABMMPUCS1 - Delta	DTP_04B9BB0HZDMR3V4VAF4NB1R3M
DTP: DP_PUCS1 -> ABMMPUCS1 - Full (WBP)	DTP_0MN0EKG5DV78033DYB404DNOI

aDSO ABMMPUCS2

The aDSO "Consignment Withdrawals (Solvay)" receives information from the Propagation Layer DSO DP_PUCS2:

Consignment Withdrawals (Solvay)	ABMMPUCS2
TRSF: IB_MM_PUCS2 -> ABMMPUCS2	0GETESQMP TVUMJODN1VE0447JRL6
IB_MM_PUCS2	IB_MM_PUCS2
TRSF: DP_PUCS2 -> IB_MM_PUCS2	01HK096K4PV9K6X9CH6NP5G0XTIVZ
Consignment Withdrawals (Solvay)	DP_PUCS2
Data Transfer Processes	ABMMPUCS2
DTP: DP_PUCS2 -> ABMMPUCS2 - Delta	DTP_04B9BB0HZDMR3U0Q6EKJNKQK

aDSO ABMMCY01

The aDSO "MM CYTEC : Material Management (PC_FILE)" is populated from the Propagation Layer DSO DPMMCY01:

MM CYTEC : Material Management (PC_FILE)	ABMMCY01
TRSF: IB_MM_CY01 -> ABMMCY01	04DCUEHIMI94GRAZAXWXXBT58AXP!
IB_MM_CY01	IB_MM_CY01
TRSF: DPMMCY01 -> IB_MM_CY01	0C7X7OEYZBO51YCJYNOEAPZVWB7F
MM CYTEC : Material Management (PC_FILE)	DPMMCY01
Data Transfer Processes	ABMMCY01
DTP: DPMMCY01 -> ABMMCY01 - Delta	DTP_04B9BB0HZDMR3V4P2V5RL8JN6

aDSO ABPOPUHD1

The aDSO "PO: Historical Data (Rhodia)" is mainly loaded from the Propagation Layer DSO DP_PUHD1. There is also a self-reflective data flow and a third transformation for loading history data from DB_PUHD1 DSO.

PO : historical Data (Rhodia)	ABPOPUHD1
TRCS IB_D1_PUHD1 -> ADSO ABPOPUHD1	0RK136R8YIJHDW3FBK19KER84O0JYUF
IB_D1_PUHD1	IB_D1_PUHD1
ADSO ABPOPUHD1 -> TRCS IB_D1_PUHD1	0Q5IPUTGHBVMTM7976CVIKW408I2MI
PO : historical Data (Rhodia)	ABPOPUHD1
TRCS IB_PO_PUHD1 -> ADSO ABPOPUHD1	06EE7AW0IWVKVD6GZVGNWGT4MP96F
IB_PO_PUHD1	IB_PO_PUHD1
ODSO DP_PUHD1 -> TRCS IB_PO_PUHD1	0QNLGSA6HSIGEOD4NQR05I8GZA4RHM
PO : Historical Data (Rhodia)	DP_PUHD1
TRSF: DB_PUHD1 -> ABPOPUHD1 (historical reload)	04DQMZG0L9V4BKQXX7TBM13UE4GL6C
PO : Historical Data (Rhodia)	DB_PUHD1
Data Transfer Processes	ABPOPUHD1
ABPOPUHD1 -> ABPOPUHD1	DTP_04B9BB0HZDMR3U0BIJ8V35B3M
DP_PUHD1 -> ABPOPUHD1	DTP_04B9BB0HZDMR3UN3P06ACGLTE
DTP: DB_PUHD1 -> ABPOPUHD1 - Delta	DTP_04B9BB0HZDMR3WW90Z2WB34V

aDSO ABPOPUHD2

The aDSO "PO: Historical Data (Solvay)" is mainly loaded from the Propagation Layer DSO DP_PUHD2. There is also a self-reflective data flow and a third transformation for loading history data from DB_PUHD2 DSO.

PO : Historical Data (Solvay)	ABPOPUHD2
TRCS IB_D2_PUHD2 -> ADSO ABPOPUHD2	0HSM6VICNP5T4V7E79EFZPF9IT632KX
IB_D2_PUHD2	IB_D2_PUHD2
ADSO ABPOPUHD2 -> TRCS IB_D2_PUHD2	0R3WIDUNB95BBNQCEE5WRRD4760TC
PO : Historical Data (Solvay)	ABPOPUHD2
TRCS IB_PO_PUHD2 -> ADSO ABPOPUHD2	07LXW0MDXDJS5E8Q0X6L37DDIZ08AK
IB_PO_PUHD2	IB_PO_PUHD2
ODSO DP_PUHD2 -> TRCS IB_PO_PUHD2	0E10MZNXWP22UXM3I0GRGLV2O3O2II
PO : Historical Data (Solvay)	DP_PUHD2
TRSF: DB_PUHD2 -> ABPOPUHD2 (historical reload)	07YTNOHCG6X9ML93C6ONCGE9H1OXN
PO : Historical Data (Solvay)	DB_PUHD2
Data Transfer Processes	ABPOPUHD2
ABPOPUHD2 -> ABPOPUHD2	DTP_04B9BB0HZDMR3V42NRTT834OI
DP_PUHD2 -> ABPOPUHD2	DTP_04B9BB0HZDMR3U08HU2CND5YQ
DTP: DB_PUHD2 -> ABPOPUHD2 - Delta	DTP_04B9BB0HZDMR3WW8XY2EW2D0

Process Chains

At present, the newly created Advanced DSOs are being loaded through the following process chains in WBP:

- PC_SPRINT_TR_B7, which runs on a daily basis, at 9:00 CET
- PC_SPRINT_TR_B99, which runs on Sundays, at 12:00 CET

Furthermore, the following process chains have been modified in WBD, in order to prepare them for future transport:

- PC_SPRINT_TR_B1
- PC_SPRINT_TR_B2
- PC_SPRINT_TR_DS2

Upon business confirmation, these chains may be transported to Production, in conjunction with the decommissioning of the objects of the legacy data flow (i.e. DSOs DB_PUCS1, DB_PUCS2, DBMMC01, DB_PUHD1 and DB_PUHD2, MultiProvider MV_SPD01, Query BW_QRY_MV_SPD01_0025, etc.).

Data loadings

Info providers and objects loaded

See Global Filters (C_GLBFLT) part, it is possible to hold loadings from one or several source systems.

SPRINT / ACETOW or PRS or RHODIA or SOLVAY

Main Chains

Process Chain	Code	Type	Frequency	Comments
SPRINT: Daily Loading	PC_SPRINT_DAILY	MAIN	<ul style="list-style-type: none"> launched by RSP_DAILY Daily Sunday night to thursday night, around 5am Whole chain lasts around 2 hours 1/2 	Not iso with WBD one. Avoid transport
SPRINT : Domain / Segment (Global)	PC_SPRINT_TR_DS1	MAIN	<ul style="list-style-type: none"> Weekly Sundays at 12am (direct scheduling) Whole chain lasts around 1 hour 	
PUNCH : Global Process Chain	PC_PUNCH_GLOBAL	MAIN	<ul style="list-style-type: none"> launched by RSP_DAILY Daily Sunday night to thursday night, around 8am Whole chain lasts around 1 hour 	
Process Chain for Shopping Cart - Main	PC_SRM_SC_ATTR	MAIN	<ul style="list-style-type: none"> launched by RSP_DAILY Daily Sunday night to thursday night, around 8am Whole chain lasts < 1 hour 	Launch SRM7
Process chain for performance reporting (Value Creation)	PC_PUPE_04	MAIN	<ul style="list-style-type: none"> Launched by event Z_EVT_PC_PUPE (triggered by webmethods application with function module Z_TRIGGER_EVENT) Daily (during the night, around 1am) 	Load file "ConvergenceToBW.csv" from server directory /exploit/BW/BOZAR
CYTEC: Process chain transactional data full	PC_CYTEC_TR_FULL	MAIN	Launched by event PC_CYTEC_TR_FULL (triggered by transaction ZBW_CYTEC_SPD)	
CYTEC MM: Transactional data Cytec MM Full	PC_CYTEC_MM_TR_FULL	MAIN	Launched by event Z_EVT_PC_CYTEC_MM_TR_FULL (triggered by transaction ZBW_CYTEC_SPD)	

Sub Chains

Process Chain	Code	Type	Frequency	Comments
SPRINT : Propagation (Rhodia)	PC_SPRINT_TR_P1	sub chain		Not iso with WBD one. Avoid transport
SPRINT : Propagation (Solvay)	PC_SPRINT_TR_P2	sub chain		Not iso with WBD one. Avoid transport
SPRINT : Propagation (Acetow)	PC_SPRINT_TR_P3	sub chain		Not iso with WBD one. Avoid transport
SPRINT: Business Layer (Rhodia)	PC_SPRINT_TR_B1	sub chain		Not iso with WBD one. Avoid transport
SPRINT: Business Layer (Solvay)	PC_SPRINT_TR_B2	sub chain		Not iso with WBD one. Avoid transport
SPRINT: Business Layer (Acetow)	PC_SPRINT_TR_B3	sub chain		Not iso with WBD one. Avoid transport
SPRINT: Business Layer (PRS)	PC_SPRINT_TR_B4	sub chain		OK. Aligned DEV/QAS/PROD
SPRINT Reporting Layer (Rhodia)	PC_SPRINT_TR_R1	sub chain		Not iso with WBD one. Avoid transport
SPRINT Reporting Layer (Solvay)	PC_SPRINT_TR_R2	sub chain		Not iso with WBD one. Avoid transport
SPRINT Reporting Layer (Acetow)	PC_SPRINT_TR_R3	sub chain		Not iso with WBD one. Avoid transport

SPRINT : Domain / Segment (Business Layer)	PC_SPRINT_TR_DS2	sub chain		Not iso with WBD one. Avoid transport caution : direct scheduling on WBP
SPRINT : Domain / Segment (Reporting Layer)	PC_SPRINT_TR_DS3	sub chain		Not iso with WBD one. Avoid transport caution : direct scheduling on WBP
PUNCH : Master Data Attributes	PC_PUNCH_MD_ATTR	sub chain		
PUNCH : Master Data Texts	PC_PUNCH_MD_TEXTS	sub chain		
PUNCH : Business Layer (Rhodia)	PC_PUNCH_TR_B1	sub chain		Caution : the Propa Layer (Rhodia) is done in PCH QM_DAILY_TRANS
PUNCH : Reporting Layer (Rhodia)	PC_PUNCH_TR_R1	sub chain		
PUNCH : Propagation layer (Solvay)	PC_PUNCH_TR_P2	sub chain		
PUNCH : Business Layer (Solvay)	PC_PUNCH_TR_B2	sub chain		
PUNCH : Reporting Layer (Solvay)	PC_PUNCH_TR_R2	sub chain		
PUNCH : PSA and Change Log Deletion	PC_PUNCH_PSA_CHG_LOG_DEL	sub chain		
Process Chain for Shopping Cart SRM7 - Main	PC_SRM7_SC_ATTR	sub chain		
Process chain SRM7 Master data	ZPC_SRM7_MASTER_DATA2	sub chain		
SRM: Global Chain	PC_SRM_001	sub chain		
SRM: MD ATTR - D - 001	PC_SRM_MD_ATTR_001	sub chain		under SRM: Global Chain
SRM: MD TXT - D - 001	PC_SRM_MD_TXT_001	sub chain		under SRM: Global Chain
SRM: TD - D - 003	PC_SRM_003	sub chain		under SRM: Global Chain
CYTEC: Process chain transactional data propagation	PC_CYTEC_TR_P1	sub chain		
CYTEC: Process chain transactional data business	PC_CYTEC_TR_B1	sub chain		
CYTEC: Process chain transactional data reporting	PC_CYTEC_TR_R1	sub chain		
CYTEC MM: Transactional data Cytec MM propagation	PC_CYTEC_MM_TR_P1	sub chain		
CYTEC MM: Transactional data Cytec MM Business	PC_CYTEC_MM_TR_B1	sub chain		
CYTEC MM: Transactional data Cytec MM Reporting	PC_CYTEC_MM_TR_R1	sub chain		

Chains for WebDynpro

Process Chain	Code	Type	Frequency	Comments
PC : Company PRS - Purchasing Scope	PC_C_COMPPRS_PSCOPE	flat file upload	On demand via Solia	Event PC_C_COMPPRS_PSCOPE
PC : Material Group Segmentation	PC_C_MAT_GRP_SEG	flat file upload	On demand via Solia	Event PC_C_MAT_GRP_SEG
PC : Material Product Code	PC_C_MATNR2_PROD	flat file upload	On demand via Solia	Event PC_C_MATNR2_PROD
PC : Plant Site	PC_C_PLANT_SITE	flat file upload	On demand via Solia	Event PC_C_PLANT_SITE
PC : Product Group Text	PC_C_PURPROD_TXT	flat file upload	On demand via Solia	Event PC_C_PURPROD_TXT

PC : Purchasing Scope Text	PC_C_PSCOPE_TXT	flat file upload	On demand via Solia	Event PC_C_PSCOPE_TXT
PC : Vendor Segmentation	PC_C_VENDID_SEG	flat file upload	On demand via Solia	Event PC_C_VENDID_SEG
PC : Vendid country	PC_C_VENDID_COUNTRY	flat file upload	On demand	Event PC_C_VENDID_COUNTRY
PC : Plant text (for Cytec source system)	PC_C_PLANT_CYTEC_TXT	flat file upload	On demand	Event PC_C_PLANT_CYTEC_TXT
PC: VENDID text (for Cytec source system)	PC_C_VENDID_CYTEC_TXT	flat file upload	On demand	Event PC_C_VENDID_CYTEC_TXT
PC: COPMPCDE text (for Cytec source system)	PC_C_COMPPCDE_CYTEC_TXT	flat file upload	On demand	Event PC_C_COMPPCDE_TEXT
PC: Company code cytec authorization scope & PRS attributes	PC_C_COMPPCDE_AUTH_PRS	flat file upload	On demand	Event PC_C_COMPPCDE_AUTH_PRS
PC: DSO DPCOMPCD Company Code Purchasing Attributes	PC_DPCOMPCD_01	flat file upload	On demand	Event Z_EVT_PC_DPCOMPCD_01
SPRINT: Master Data Material group text	PC_C_MAT_GRP_CYTEC_TXT	flat file upload	On demand	Event Z_EVT_PC_C_MAT_GRP_CYTEC_TXT
SPRINT: Master Data - Material Text	ZWD_FILE_C_MATNR2_TXT	flat file upload	On demand	Event Z_EVT_PC_C_MATNR2_CYTEC_TXT

Other Chains

Process Chain	Code	Type	Frequency	Comments
S3: Reporting Tool	PC_SPEND_S3_01	Flat File Upload	On a Business request	Run manually

Loading frequency

Process Chain PC_SPRINT_DAILY runs daily, Sunday night to thursday night, around 5am.

Process Chain PC_SPRINT_TR_DS1 runs weekly on sundays at 12am

Average performance

Key Figure	Estimation
~ Average Process Chain Runtime	Daily Main Process Chain lasts around 2 hours 1/2 Weekly Process Chain lasts around 1 hour
~ Average nb of rows loaded per load	
~ Total nb of rows loaded (if full)	
~ Average Runtime for 10k lines	

Record Keeping

No historisation in place.

For FIAP/FIGL, current year + 3 previous ones are requested

For Po Schedule lines, schedule lines from 01/01/2013 are available

Reporting

Queries End User Documentation

SPRINT training & SPRINT presentation

<https://drive.google.com/a/solvay.com/folderview?id=0B5Ivsv4WTtUbVktFZINVRkNYU1k&usp=sharing>

Main queries

Main functionalities

MaintenanceBroadcast

No Broadcast implemented

Known bugs

Recurring procedure

Variables (TVARV/Global Filters)

Variable (TVARVC)

Variable	Explanation
LOGSYS_A , LOGSYS_R, LOGSYS_S A= Acetow, R=Rhodia, S=Solvay	Bex variable V_LOGSYS_0007 used to fill query prompt => SE24 ZCL_BIU001_V_0LOGSYS_0007

Global Filters (C_GLBFLT)

Stream	Rule	Explanation
SPRINT	DB_FIA P1 DB_FIA P2	Variable used in transformation (start routine) between DBFIAP01/2 => DB_FIAP1/2. Aim : skip the DSO DB_FIAP1/2 lookup. In case of a reloading of FIAP, this look-up is not usefull. To optimize loading time, set the filter to Y. Do not forget to put it back to N afterwards.
SPRINT	SEGME NTAT	Variable used in DTP filter to define the number of year to consider for segmentation redetermination DSOs : DB_FIAP1/2/3 + DB_PUHD1/2/3 + DB_PUSL1/2/3
SPRINT	CLASS_X	Variable used in transformation to load Vendor number from DataSource 0VENDOR_ATTR / Solvay currently : interval P000000000 and PZZZZZZZZZ
SPRINT	ACETOW RHODIA SOLVAY PRS	Theses variables are used in Process Chains. After the loading of the attributes of the master data, there is a decision (one by source system) to launch or not the loading of the transactionnal data
FIAP	DOC_TY P_4	Variable used in query BW_QRY_MV_SPD01_0008 in selection screen. A huge list of values are taking into account. This variable reach limit of number of ligne to display in a selection screen in Analyzis if you put the variable "Ready for Input" Example of values : 18 + 19 + 23 + 24 + 43 + 44 + 48 + 49 + 53 + 54 + 63....

FIAP	PREV_YEAR	Nb prev years for period DTP DSO DB_FIAP* -> DB_FIAP* OLD!! Obsolete : has been replaced by variable SPRINT / SEGMENTAT
SPRINT	C_PURRQI	DTS_BW_PR_CHANGEDOC --> MD_C_PURRQI init => Value = Y If value = Y, it means we want to re-init the masterdata C_PURRQI, the current Release Date has to be replaced. If value = N, it means it is normal process, the current Release do not have to be changed to keep the initial one.
SPRINT	CR_PUAP3	Variable used in start routine between ODS DB_FIAP3 and cube CR_PUAP3 to not taking into account one company code
SPRINT	0AC_DOC_NO	Exclusion doc FIAP FIGL: src_syst/ac_doc/year/compcode/item
SPRINT	DB_FIAP3	Exclusion of company code in start routine of DB_FIAP3
SPRINT	WEBDYNPRO	SPRINT: TIME ALLOWED FOR WEB DYNPRO LOADING
SPRINT	C_VND_AT1	Value of c_vnd_at1 used by default for new entries in master data c_vendid (see transformations of master data)
BOZAR	BFC_VBF	Exclusion BFC 0001 for calc of VBF in DB_BOCAL
BOZAR	C_BUSLINE	Exclusion of business line in start routine dso DBPUPE02
BOZAR	DATE_PERF	Select data after year to not have multi year in DBPUPE02 (201412)
BOZAR	PROGRAM	Select data with program to exclude on DSO DBPUPE02 (Supply Chain Excellence)
BOZAR	%VBF	Default percentage VBF in transformation DB_BOCAL DB_BOCAL (cases where %VBF per domain not filled in filters) (4.5)
BOZAR	I%VBF	Default %VBF in trf DB_BOCAL -> DB_BOCAL when I%VBF is empty (cases where I%VBF per domain not filled in filters) (5)

FIAP Reloading

FIAP for SPRINT Dsos (CR_PUAP1/2/3), and Cubes (CR_PUAP1/2/3) have been reloaded several times since project golive.

At least Sprint needs: current year + 3 previous ones.

Example 2016 => 2016 + 2013 to 2015

See ModOp SPRINT reloadings https://drive.google.com/file/d/1mcse4gg1zrU6J0g_TailnWUJYPkmbm5FI8VSEIaq0rc/view

Caution :

- Cube level takes a long time to reload! Users have to be informed before and after the reload.
- A check Before/After image has to be done. Only opened periods should be different.
- A check between FIAP for Sprint & Cubes for Working Capital has to be done also.
- **Don't forget to load data from Factoring DSO (DBFIAP05 + DBFIAP06 + DBFIAP07) to SPRINT DSO (DB_FIAP1 + DB_FIAP2 + DB_FIAP3) after the loading from business dso (DBFIAP01 + DBFIAP02 + DBFIAP04) .**
And after that, load DSO on himself to do the lookup with readsoft DSO (transformation TRSF: DB_FIAP2 -> IFS_DB_FIAP2_DB_FIAP2 - ReadSoft (Solvay) or TRSF: IFS_DB_FIAP1_DB_FIAP1 -> DB_FIAP1 - ReadSoft (Rhodia)).
Example:

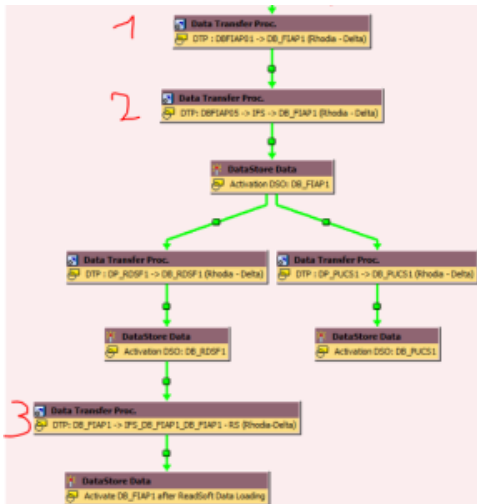

Test Queries to check data Sprint vs WC + common DSOs :

- ZTEST_MV_SPD01_CHECKFIAP_001 / SPRINT - Check FIAP loadings (SPRINT Cubes)
- ZTEST_MVFIWC01_CHECKFIAP_001 / SPRINT - Check FIAP loadings (WC Cubes)
- ZTEST_MVFIWC03_CHECKFIAP_001 / SPRINT - Check FIAP loadings (Common Dsos)

Data can be check a company code level. Make sur all the demand in common split DSO are loaded into Sprint Dsos/Cubes and WC Cubes

FIAP Specifics Rules

On DB_FIAP DSO, during the delta loading (from DBFIAP* to DB_FIAP*) if the material code (C_MATNR2) is empty, we take the material from master data C_PO_ITEM.

DB_FIAP3 - FIAP for SPRINT (Acetow):

In transformation TRSF : DBFIAP04 -> DB_FIAP3 (Acetow), in start routine with help of master data global filter (C_GLBFILF, Stream SPRINT, Rule DB_FIAP3) we delete data with company code 7315 with posting date before 01.05.2017.

Status of payment

In transformation between ODS DBFIAP* and DB_FIAP* we define the several status of payment. It's a little bit complicated to understand, is why we have one document to resume the rules:

https://drive.google.com/file/d/1M0AbEM5ptK_qTziwj88Z_vy0KMFTWuXCG7v8itC5EWM/view

Link with factoring level (CAMS project).

New sources was added in Sprint FIAP flow: DBFIAP05, DBFIAP06 and DBFIAP07.

The goal of these new sources it's to update if necessary some information like clearing date or clearing doc (take into account clearing from factoring dso and not only fiap dso).

For more detail, check this documentation:

https://drive.google.com/file/d/1voS1QF_wu84RFjOpqDqFPX0ddUgWzY6UQLW8ABhn4Ig/view

Exclusion of some accounting document number:

This procedure should only be applied if the purchasing data team has requested it (Sylvie Severini or Yi Ting Kuo) by ticket.

There are some exclusions in transformations (start routines) between DSO DBFIAP01 / 02 / 04 to DB_FIAP1 / 2 / 3 (FIAP line Item Splitted -> FIAP for Sprint).

Exclusion is also made in expert routine in transformations from DSO FIAP : Line Item Splitted - Factoring Level 2 and DSO FIAP for Sprint.

The goal is exclude several accounting documents with inconsistent values. For that, abap code will be read master data global filter with attributes:

Stream	SPRINT
Rule	OAC_DOC_NO

In field "Low" of master data, values must be entered in format : source system/accounting document number/item number/year/company code

Example:

Stream	Rule	Counter	Global Filter Descri	Sign	Option	Low	Hight	Active
SPRINT	OAC_DOC_NO	1	Exclusion doc FIAP FIGL: src_syst/ac_doc/year/compcode/item	I	EQ	DF1_020/6311186851/1/2016/4290		Y

With that, abap code will remove from source package rows with these informations.

You can find impacts on queries on the file below:

<https://drive.google.com/file/d/1Stem0UEeHcBhF1snbsakNV-ciQ5ogeATLwExuebaeNw/view>

It may be necessary to exclude new documents.

To do that, it's necessary to now the source system / document / item number / year / company code and update master data global filter.

Then, make a selective deletion on fiap cube and dso on accounting document / company code / year (it's not possible to delete only accounting document concerned because item number isn't available in cube fiap).

When selective deletion is done, reload data on DSO Sprint with DTP with same filters used for selective deletion.

All data will be recovered, except documents on master data global filter (for some item number).

When Sprint FIAP DSO is reload, launch delta dtp to reload SPRINT FIAP cube.

For more detail, check this documentation:

<https://drive.google.com/file/d/1o98yNBZKk2VIY0d3vw0bMfmY7TuwfqkOghC6nLLPQWQ/view>

FIGL Specifics Rules

Be careful, there is a rule between propagation DSO and business DSO to exclude lines with FIGL Domain not equal to "AP".

Exclusion of some accounting document number:

This procedure should only be applied if the purchasing data team has requested it (Sylvie Severini or Yi Ting Kuo) by ticket.

There are some exclusions in transformations (start routine) between DSO FIAP : AP from FIGL: Line Items - Level 2 and Cubes: FIGL for SPRINT.

The goal is exclude several accounting documents with inconsistent values. For that, abap code will be read master data global filter with attributes:

Stream	SPRINT
Rule	OAC_DOC_NO

In field "Low" of master data, values must be entered in format : source system/accounting document number/item number/year/company code

Example:

Stream	Rule	Counter	Global Filter Descri	Sign	Option	Low	Hight	Active
SPRINT	OAC_DOC_NO	1	Exclusion doc FIAP FIGL: src_syst/ac_doc/year/compcode/item	I	EQ	DF1_020/6311186851/1/2016/4290		Y

With that, abap code will remove from source package rows with these informations.

You can find impacts on queries on the file below:

<https://drive.google.com/file/d/1Stem0UEeHcBhF1snbsakNV-ciQ5ogeATLwExuebaeNw/view>

It may be necessary to exclude new documents.

To do that, it's necessary to know the source system / document / item number / year / company code and update master data global filter.

Then, make a selective deletion on fiap cube and dso on company code / year (it's not possible to delete only accounting document concerned because accounting document and item number aren't available in cube FIGL for SPRINT).

When selective deletion is done, reload data on DSO SPRINT with DTP with same filters used for selective deletion.

All data will be recovered, except documents on master data global filter (for some item number).

Be careful, there is a rule between propagation DSO and business DSO to exclude lines with FIGL Domain not equal to "AP". It could happen some documents with at the origin the FIGL Domain at "AP" and then the domain change. So when we make the selective deletion and after the reloading, these lines aren't loaded.

When SPRINT FIGL DSO is reload, launch delta dtp to reload SPRINT FIGL cube.

For more detail, check this documentation:

<https://drive.google.com/file/d/1o98yNBZKk2VIY0d3vw0bMfmY7TuwfqkOghC6nLLPQWQ/view>

FIGL Reloading

Caution, take into account special periods 013 to 016, otherwise December figures will be wrong.

Special periods 013 to 016 are at last stored on period 012.

See ModOp SPRINT reloadings https://drive.google.com/file/d/1mcse4gg1zrU6J0g_TailnWUJYPkmbm5FI8VSEIaq0rc/view

It is important to check image Before/After. Only opened periods could be different.

ReadSoft Reloading

See ModOp SPRINT reloadings https://drive.google.com/file/d/1mcse4gg1zrU6J0g_TailnWUJYPkmbm5FI8VSEIaq0rc/view

For information, at the reloading of readsoft there have been issue during activation of data in DSO DB_RDSF1 & DB_RDSF2.

Some rows had currency = USA, chinese character in field wc user and "!" in the beginning of field Reference document number.

So there is an exclusion in DTPs when currency = USA and routines to clear strange characters for wc user and reference document number.

Manual update

It can happen that some Readsoft Cockpit Documents were manually updated in WP1 and PF1 (to force the Clearing Document and Clearing Date and reset the status).

In this case and for the moment, to update the changes in bw the solution is:

1. Take the list of cockpit document modified in a excel file (1.1).

	A	B	C	
1	'.Append S_T_RANGE TO l_t_range.			
2	S_T_RANGE-LOW = '			(2.1 + 3.1)

2. On the first rows, write this:

3. Use excel function: =CONCATENER(\$A\$2;A7;\$A\$1) to obtain:

	A	B	C	D	E	F	G
1	'.Append S_T_RANGE TO l_t_range.			2.1			
2	S_T_RANGE-LOW = '			3.1			
3							
4	1.1						
5			3.2	1.2		2.2	
6							
7	905578		S_T_RANGE-LOW = '905578'.Append S_T_RANGE TO l_t_range.				
8	1723247		S_T_RANGE-LOW = '1723247'.Append S_T_RANGE TO l_t_range.				
9	2422060		S_T_RANGE-LOW = '2422060'.Append S_T_RANGE TO l_t_range.				
10	2998855		S_T_RANGE-LOW = '2998855'.Append S_T_RANGE TO l_t_range.				
11	4865172		S_T_RANGE-LOW = '4865172'.Append S_T_RANGE TO l_t_range.				

4. When we have all rows, we copy the text and paste in abap routine in full infopackage:
Excel file is usefull only to concatenate the differents elements, don't use excel file in infopackage, just need to copy and paste the text result (rows in yellow).

```

*$$$ begin of routine - insert your code only below this line
data : S_T_RANGE TYPE rssidrange .
S_T_RANGE-FIELDNAME = 'DOCNO'.
S_T_RANGE-SIGN = 'I'.
S_T_RANGE-OPTION = 'EQ'.
S_T_RANGE-LOW = '905578'.Append S_T_RANGE TO l_t_range.
S_T_RANGE-LOW = '1723247'.Append S_T_RANGE TO l_t_range.
S_T_RANGE-LOW = '2422060'.Append S_T_RANGE TO l_t_range.

S_T_RANGE-LOW = '1721088'.Append S_T_RANGE TO l_t_range.
data: l_idx like sy-tabix.
read table l_t_range with key
      fieldname = 'DOCNO'.
l_idx = sy-tabix.
*....
modify l_t_range index l_idx.

```

Like this, we can filter on several cockpit document in one load from sap to bw, and not one document by on document.

Don't forget to delete the routine in infopackage after the reloading;

Value Creation

Data flow

▼ Purchasing Sprint - Value Creation - Virtual	IA_PUR_SPRINT_VC_VIRTUAL	Change
▼ Performance Reporting	MVPUPE01	Change
▼ Performance Reporting	CRPUPE01	Manage
▼ TRSF: ODSO DBPUPE01 -> CUBE CRPUPE01	09H6GBJJQLNT3MGWGUCLYFYNH6LOZAF	Change
▼ DSO / Performance (SalesForce) - Business	DBPUPE01	Manage
▼ TRSF: ODSO DPPUPE01 -> ODSO DBPUPE01	00ZHY8KACHLSXSIPAGSJWZDBVL869HR9	Change
▼ DSO / Performance (SalesForce) - Propagation	DPPUPE01	Manage
▼ TRSF: RSDS DTS_PUPE_01 PC_FILE -> ODSO DPPUPE01	02MK1MRMA3VRKYL76NXOYBACFA3CA0R	Change
▼ Purchasing Performance	DTS_PUPE_01	Change
• IP: DTS_PUPE_01 PC_FILE - Full	ZPAK_59VW47HGQHWNFTRMHD1IH9PNU	Execute

Source data for Value Creation come from Convergence source system and loaded in bw server with help of webmethods (Transaction AL11 directory /exploit/BW/BOZAR filename "ConvergenceToBW.csv").

Normally, webmethods launch event Z_EVT_PC_PUPE to run process chain PC_PUPE_04 and load automatically dso and cube.

Interface Value Creation: Salesforce-Webmethods-BW-QV

Power of two update:

With PO2 project, we had to add C_AUTHMA object in Performance data flow.

The issue is we don't have any object linked (like C_COMPCDE) with C_AUTHMA in source of data (flat file from convergence). It was decided to add a code in convergence side after the GBU.

It means, in flat file we received a field with three characters for the GBU instead two:

PSA Maintenance					
Data records to be					
DataPacket	Data Rec.	Action	/BIC/C_GBU	Old Ac	
1	1	A-029824	CH1		
1	2	A-029825	SD1		
1	3	A-029826	SD1		
1	4	A-029827	SD1		
1	5	A-029532	PA2		

And in propagation DSO, the field CPFCTR1_2 is replaced by C_GBUSCOP (with three characters).

Between the propagation and the business DSO in transformation TRSF: ODSO DPPUPE01 -> ODSO DBPUPE01, a lookup with master data global filter is done to retrieve the C_AUTHMA associated to the code (0, 1, 2, Z) and split the C_GBUSCOP in CPFCTR1_2 with the two first characters and the C_AUTHMA with the text associated to the code.

Table: /BIC/PC_GLBFLT										
/BIC/C_STREAM	/BIC/C_RULE	/BIC/C_GLBFLT	OBJVERS	CHANGED	/BIC/C_DESC	/BIC/C_SIGN	/BIC/C_OPTION	/BIC/C_LOW	/BIC/C_HIGH	/BIC/C_ACTIVE
PUPE	C_AUTHMA	001 A			Define C_AUTHMA in dso DBPUPE01 in function of C_GBU...	I	EQ	0	SOLVAY	Y
PUPE	C_AUTHMA	002 A			Define C_AUTHMA in dso DBPUPE01 in function of C_GBU...	I	EQ	1	ECO	Y
PUPE	C_AUTHMA	003 A			Define C_AUTHMA in dso DBPUPE01 in function of C_GBU...	I	EQ	2	SCO	Y
PUPE	C_AUTHMA	004 A			Define C_AUTHMA in dso DBPUPE01 in function of C_GBU...	I	EQ	Z	SOLD	Y

It means C_GBUSCOP = CH1 is transformed in CPFCTR1_2 = CH and C_AUTHMA = ECO. All records with "1" in C_GBUSCOP are ECO, with "2" are SCO.

The C_AUTHMA is added in cube and multiprovider, then used in queries with authorization variable.

Master Data:

One master data text (C_BUSLINE) is filled by process chain PC_PUPE_02 (sub chain of PC_PUPE_04). Texts come from data source DTS_PUPE_01 (same as transactional data of data flow Value Creation).

There is another master data used for Value Creation:

Calculation Rule	C_ACTCALC
Calculation Rule (Attributes)	ATTRIBUTES C_ACTCALC
TRSF: RSDS DTS_PUPE_02 PC_FILE -> IOBJ C_ACTCALC	0OP1RTXMK02SD624PDYLN9NGVZ9554OY
Performance Calculation Rule	DTS_PUPE_02
IP: DTS_PUPE_02 PC_FILE - Full	ZPAK_5BH8JAYH6VV0ZMTF8QK05BHNU
Data Transfer Processes	ATTRIBUTES C_ACTCALC
Calculation Rule (Texts)	TEXTS C_ACTCALC

This master data is maintain on demand of purchasing team (Sylvie.Severini or Yi Ting Kuo).

In case of change, for attributes it's necessary to prepare a csv file in this format for example:

A	B
Rule 01	Cost
Rule 02	Cost
Rule 03a	Cost
Rule 03b	CAPEX
Rule 03c	Cost
Rule 04	Cost
Rule 05	Cash
Rule 06	Cash
Rule 07	Cash
Rule 09	Contrib
Rule 10	Innovation

Then load the file in master data (change the source file of infopackage before to use the new file). For texts, for the moment, we change directly in text table of master data,.

Technical points to pay attention

Datasource DTS_PUPE_01: please to check data don't use "PSA Maintenance" button but use directly PSA table /BIC/B0011690001. Because of field description with type CHAR length 600 in datasource if we use "PSA Maintenance" we have a dump. It's necessary to have a length of 600 to retrieve all information of description (this field will be splited in next transformation).

How monitoring the loading ?

Check process chain PC_PUPE_04 between 1:00:00 am Paris Time (Hours where the flat file is sent from convergence to BW sever) and before 7:00:00 am Paris Time (hour where qlikview run the query to load the dashboard).

If the process chain is not in progress or completed, look on Tcode AL11 and find the flat file (directory /exploit/BW/BOZAR filename "ConvergenceToBW.csv").

If the file is the date of the day, there has been an issue when launching the process chain.

If the file has a date of day before, there is an issue to load flat file with webmethod. Please create a Freshdesk ticket or direct contact Support. XML@solvay.com.

If the process chain is in error, please investigate on the type of issue. In case of invalid value or invalid character please contact Salesforce team (Sylvie.Severini@solvay.com) If she is unavailable, send a mail to gps.pur@solvay.com) to know if it's a source problem and if it's possible to correct the issue in Salesforce.

If the value creation data are loaded in cube CRPUPE01 after 7:00:00 am (Paris time), please contact Qlikview team to ask to reload manually the dashbord PPV (Performing Performance Visibility).

Load data manually in case of issue

In all cases, when data are loaded in BW, please contact QlikView team to reloaded Purchasing Performance Visibility dashboard.

There can be three types of errors:

1. Webmethods loaded file in bw server (/exploit/BW/BOZAR) but he was unable to launch the event: Use function module Z_TRIGGER_EVENT to trigger event Z_EVT_PC_PUPE to load data in bw.
2. Webmethods can't trigger the event and also load data in bw server:

- a. If webMethods team can send the file to load to bw team:

BW team need to update infopackage "IP: DTS_PUPE_01 PC_FILE - Full" to use local file and not server file (do not forget to hand over server file after).

Then, load data on DTS_PUPE_01 and after that run process chain PC_PUPE_03 (Go to transaction SE37, run Function Module RSPC_API_CHAIN_START):

Test Function Module: Initial Screen

Import parameters	Value
I_CHAIN	PC_PUPE_03
I_T_VARIABLES	0 Entries
I_SYNCHRONOUS	
I_SIMULATE	
I_NOPLAN	
I_DONT_WAIT	
I_POLL	

Wait for data to be loaded, then run also PC_PUPE_02 (Texts).

- b. If webMethods team can't send the file to load to bw team:

Load data manually from Salesforce

1. Connect to Salesforce. If you do not have access, contact Sylvie Severini to have an account created. If she is unavailable, send a mail to gps.pur@solvay.com
2. In Dashboards, open Report "CONVERGENCE><SPRINT".

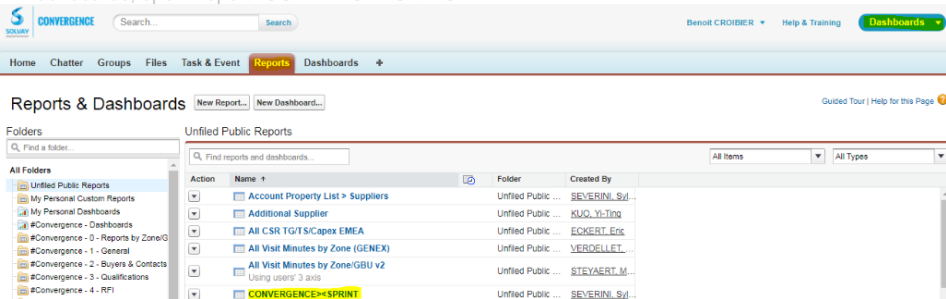

3. Run Report, wait for the page to reload, then Export Details.

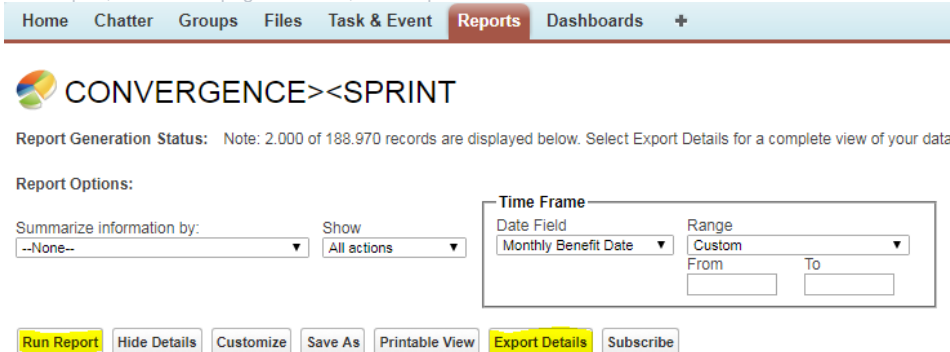

- Select UTF-8 and format csv, then click Export.

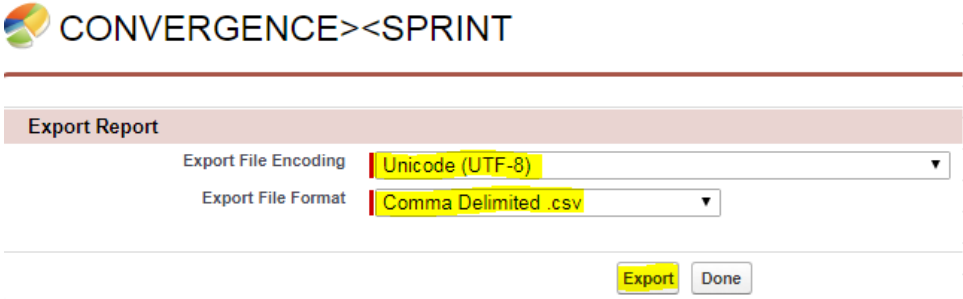

- Open file in Excel and apply the following changes:
 - Remove N/A in all fields (Select All, press Ctrl+F, search for N/A leaving "replace by" field blank, Replace All)
 - Replace comma (,) by dot (.) in numeric columns (Exchange Rate + Last 8 columns) using the same method as above.
 - Insert a new column after Implementation Date. Copy column Implementation Date in new column Implementation Month.
 - Update date formats of these two columns and Creation Date - DD.MM.YYYY for Implementation Date and Creation Date, YYYYMM for Implementation Month
 - Insert new columns Action Recovery and Benefit Recovery
 - Use model here
(Tab: Source Data) to order the fields correctly.
If you can't access the file, go to DataSource DTS_PUPE_01 and look up the fields list.
Don't forget to add an empty column before Sequence (Monthly Benefit Date, not used as of yet)
 - Save the file as csv (semi-colon (;) separated)
- Connect to WBP. You will likely need FireFighter authorization. Go to DataSource DTS_PUPE_01, open "IP: DTS_PUPE_01 PC_FILE - Full" and change extraction target.
Adapter = Load Text File from Local Workstation
File name = Name (and full path) of the extracted csv
Don't forget to come back here to return to the previous setting after completing your reload!
Run Extract.
- Once data is loaded in PSA, Run Process Chain **PC_PUPE_03** (Go to transaction SE37, run Function Module RSPC_API_CHAIN_START)

Test Function Module: Initial Screen

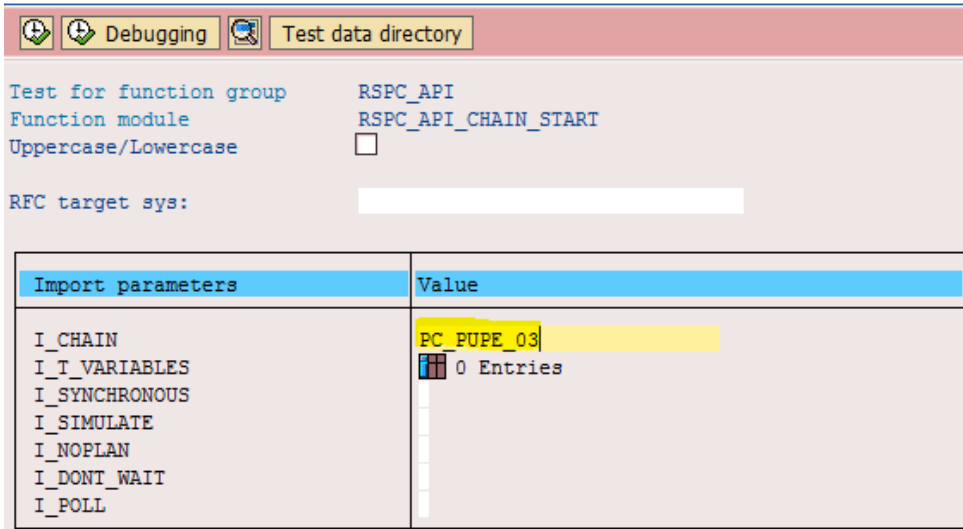

- Wait for data to be loaded, then run also **PC_PUPE_02** (Texts).

Working document

https://drive.google.com/file/d/1YJw6Hla_TuG1hjkZR17WQoExfevNJ0IW9ia_Uytxnrw/view

Contacts for value creation:

- Webmethod: Freshdesk ticket and direct contact with Support.XML@solway.com.
- Salesforce: Sylvie.Severini@solway.com If she is unavailable, send a mail to gps.pur@solway.com
- Qlikview: Freshdesk Ticket.

SPRINT data exported to other applications

Open Hub

Planned Evolution

These evolutions are currently in progress (list to be updated)

- **Evolution for OFI_AP_4 / Solvay extractor** to delete rule on Reference field (BKPF-XBLNR) + extension for House bank field (BSEG-HBKID)

First analysis : <https://drive.google.com/file/d/1GzJei0CCHhVDLfkEXzlvHn4i3n1P4OE5SGJZCkt4D0/view>

Useful transactions / programs

Transaction	Description	Corresponding table	Comments
XK03	Display Vendor (Central)	LFA1	
MK03	Display Vendor (Purchasing)	LFM1/LFM2	
FK03	Display Vendor (Company Code)	LFB1	
ME23N	Display Purchase Order	EKKO/EKPO	
ME53N	Display Purchase Request	EBAN	
FB03	Display Accounting Document	MKPF/BSEG BSIK/BSAK	
ME13	Display Purchase Info Record (PIR) Afficher Fiche Info Achat (FIA)		to display scale (barème) choose "conditions" then icon "steps (marches) example RCS : Info Record 53002260253 or 5300260253
ME03	Display Source List		source d'approvisionnement example RCS : material 1050025 / plant 7822
ZBW_VBF_LOAD	Load VBF filters and calculate VBF	ZBW_LOAD_FILE_VBF_FILTERS	Linked to authorization ZR_RCS_CA_M591
ZBW_VBF_LOAD_2	Load VBF filters and calculate VBF for SCO	ZBW_LOAD_FILE_VBF_FILTER_S_2	
ZBW_CYTEC_SPD	Load CYTEC transactional data	ZBW_LOAD_FLAT_FILE_CYTEC	Linked to authorization ZR_RCS_CA_M041